

◆ ◆ ◆ ◆ ◆
◆ ◆ ◆ ◆ ◆
Instruction manual

◆ ◆ ◆ ◆ ◆
◆ ◆ ◆ ◆ ◆
**Operational instructions
for digital Multibus
Mass Flow / Pressure instruments**

Doc. no.: 9.17.023AM Date: 13-11-2019

◆ ◆ ◆ ◆ ◆
◆ ◆ ◆ ◆ ◆
◆ ◆ ◆ ◆ ◆
◆ ◆ ◆ ◆ ◆
ATTENTION
Please read this instruction manual carefully before installing and operating the instrument.
Not following the guidelines could result in personal injury and/or damage to the equipment.



Disclaimer

The information in this manual has been reviewed and is believed to be wholly reliable. No responsibility, however, is assumed for inaccuracies. The material in this manual is for information purposes only.

Copyright

All rights reserved. This documentation is protected by copyright.

Subject to technical and optical changes as well as printing errors. The information contained in this document is subject to change at any time without prior notification. Bronkhorst High-Tech B.V. reserves the right to modify or improve its products and modify the contents without being obliged to inform any particular persons or organizations. The device specifications and the contents of the package may deviate from what is stated in this document.

Symbols



Important information. Discarding this information could cause injuries to people or damage to the Instrument or installation.



Helpful information. This information will facilitate the use of this instrument.



Additional info available on the internet or from your local sales representative.

Warranty

Bronkhorst® products are warranted against defects in material and workmanship for a period of three years from the date of shipment, provided they are used in accordance with the ordering specifications and the instructions in this manual and that they are not subjected to abuse, physical damage or contamination. Products that do not operate properly during this period may be repaired or replaced at no charge. Repairs are normally warranted for one year or the balance of the original warranty, whichever is the longer.



See also paragraph 9 of the Conditions of sales:

http://www.bronkhorst.com/files/corporate_headquarters/sales_conditions/en_general_terms_of_sales.pdf

The warranty includes all initial and latent defects, random failures, and undeterminable internal causes.

It excludes failures and damage caused by the customer, such as contamination, improper electrical hook-up, physical shock etc.

Re-conditioning of products primarily returned for warranty service that is partly or wholly judged non-warranty may be charged for.

Bronkhorst High-Tech B.V. or affiliated company prepays outgoing freight charges when any party of the service is performed under warranty, unless otherwise agreed upon beforehand. However, if the product has been returned collect to our factory or service center, these costs are added to the repair invoice. Import and/or export charges, foreign shipping methods/carriers are paid for by the customer.

TABLE OF CONTENTS

1	GENERAL PRODUCT INFORMATION	5
1.1	INTRODUCTION	5
1.2	MULTIBUS TYPES.....	5
1.3	REFERENCES TO OTHER APPLICABLE DOCUMENTS	6
2	DIGITAL INSTRUMENT	7
2.1	GENERAL.....	7
2.2	BASIC DIAGRAM.....	7
2.3	MEASURE AND CONTROL FUNCTIONAL BLOCK DIAGRAM	9
2.4	CALIBRATION WITH MATHEMATICAL FUNCTIONS.....	10
2.5	MULTI FLUID / MULTI RANGE INSTRUMENTS.....	11
3	PARAMETERS AND PROPERTIES	12
3.1	GENERAL.....	12
3.2	BRONKHORST® SOFTWARE	12
3.3	PARAMETER USE	13
4	NORMAL OPERATION PARAMETERS	15
4.1	MEASURE UNIPOLAIR	15
4.2	MEASURE BIPOLAIR	15
4.3	FMEASURE.....	15
4.4	SETPOINT	16
4.5	FSETPOINT.....	16
4.6	SETPOINT MONITOR MODE	16
4.7	SETPOINT EXPONENTIAL SMOOTHING FILTER	16
4.8	SETPOINT SLOPE.....	17
4.9	ANALOG INPUT	17
4.10	CONTROL MODE.....	17
4.11	SLAVE FACTOR.....	18
4.12	FLUID NUMBER	18
4.13	FLUID NAME.....	18
4.14	VALVE OUTPUT	19
4.15	TEMPERATURE.....	19
4.16	ACTUAL DENSITY	19
4.17	SENSOR TYPE.....	19
4.18	CAPACITY 100%	19
4.19	CAPACITY 0%.....	19
4.20	CAPACITY UNIT INDEX.....	20
4.21	CAPACITY UNIT	21
5	CONTROL PARAMETERS.....	22
5.1	PID-Kp.....	22
5.2	PID-Ti.....	22
5.3	PID-Td.....	22
5.4	CONTROLLER SPEED	22
5.5	OPEN FROM ZERO RESPONSE	22
5.6	NORMAL STEP RESPONSE	23
5.7	STABLE RESPONSE	23
5.8	SENSOR DIFFERENTIATOR UP	23
5.9	SENSOR DIFFERENTIATOR DOWN.....	23
5.10	SENSOR EXPONENTIAL SMOOTHING FILTER.....	23
5.11	VALVE SAFE STATE	24
6	ALARM / STATUS PARAMETERS	25
6.1	GENERAL.....	25
6.2	FUNCTIONAL ALARM SCHEMATIC.....	25
6.3	ALARM INFO	26
6.4	ALARM MODE	26

6.5	ALARM MAXIMUM LIMIT.....	26
6.6	ALARM MINIMUM LIMIT	26
6.7	ALARM SETPOINT MODE	26
6.8	ALARM NEW SETPOINT	26
6.9	ALARM DELAY TIME	27
6.10	RESET ALARM ENABLE	27
6.11	STATUS.....	27
6.12	STATUS OUT POSITION.....	27
6.13	USING AN ALARM (EXAMPLES)	28
7	COUNTER PARAMETERS	29
7.1	COUNTER VALUE	29
7.2	COUNTER MODE	29
7.3	COUNTER SETPOINT MODE	29
7.4	COUNTER NEW SETPOINT	30
7.5	COUNTER LIMIT	30
7.6	COUNTER UNIT INDEX.....	30
7.7	COUNTER UNIT	31
7.8	RESET COUNTER ENABLE	31
7.9	COUNTER CONTROLLER OVERRUN CORRECTION	32
7.10	COUNTER CONTROLLER GAIN.....	32
7.11	USING A COUNTER (EXAMPLE).....	32
8	IDENTIFICATION PARAMETERS	33
8.1	SERIAL NUMBER.....	33
8.2	BHTMODEL NUMBER	33
8.3	FIRMWARE VERSION	33
8.4	USERTAG.....	33
8.5	CUSTOMER MODEL	33
8.6	IDENTIFICATION NUMBER	34
8.7	DEVICE TYPE.....	34
9	SPECIAL PARAMETERS	35
9.1	RESET	35
9.2	INITRESET	35
9.3	WINK	35
9.4	IOSTATUS	35
10	SPECIAL INSTRUMENT FEATURES.....	38
10.1	ZEROING	38
10.2	RESTORE PARAMETER SETTINGS.....	39
10.3	BUS CONFIGURATION MODE	40
11	MANUAL INTERFACE: MICRO-SWITCH AND LED'S	41
11.1	GENERAL.....	41
11.2	LED'S INDICATIONS	42
11.3	MICRO-SWITCH USE FOR READING / SETTING ADDRESS / MAC-ID AND BAUDRATE	45
11.4	MICRO-SWITCH USE FOR READING/CHANGING CONTROL MODE:	48
12	TESTING AND DIAGNOSTICS	49
13	SERVICE	50

1 GENERAL PRODUCT INFORMATION

1.1 INTRODUCTION

This user guide explains the functioning of Bronkhorst® digital Multibus instruments features and parameter structure. They are called **MULTIBUS** instruments because the digital instruments may be fitted with a field bus. At this moment the following types of field buses are supported: FLOW-BUS, Modbus, DeviceNet, PROFIBUS DP, PROFINET and EtherCAT. Therefore included herein is the basic information to operate a digital instrument with optional field bus. Explained is the functioning of the several parts of a digital system as the measuring system, control settings, alarm and counter use and identification parameters. For every field bus a separate user guide is available.

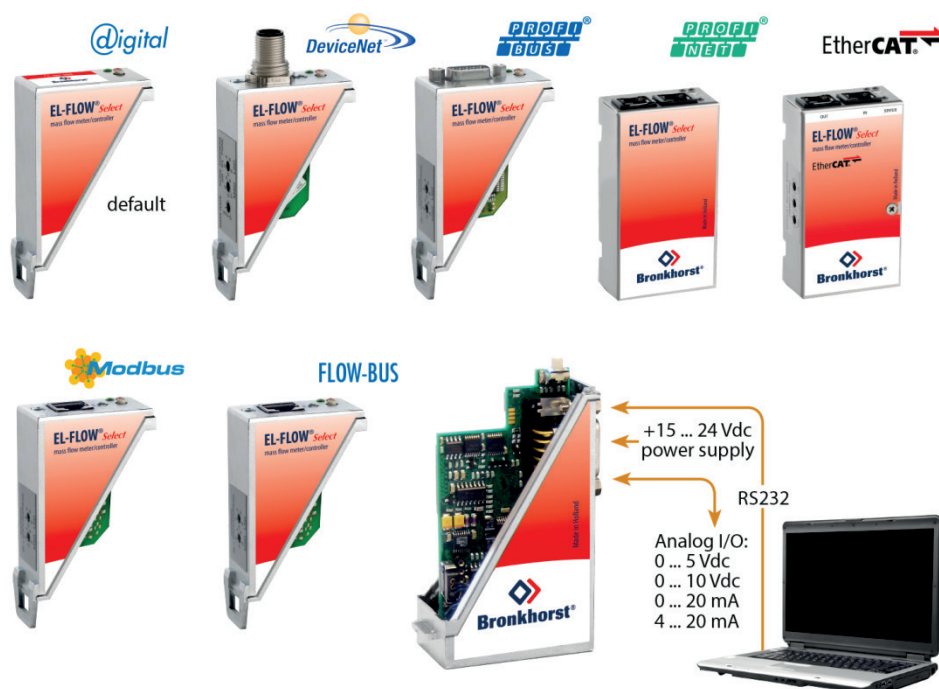

1.2 MULTIBUS TYPES

In 2000 Bronkhorst® developed their first digital instruments according to the “multibus” principle. The basic pc-board on the instrument contained all of the general functions needed for measurement and control, including alarm, totalizing and diagnostic functions. It had **analog** I/O-signals and also an **RS232** connection as a standard feature. In addition to this there is the possibility of integrating an interface board with **DeviceNet™**, **PROFIBUS DP**, **PROFINET**, **Modbus**, **FLOW-BUS** or **EtherCAT** protocol. The first generation (**MBC-I**) was based on a 16 bit Fujitsu controller. It was superseded in 2003 by the Multibus type 2 (**MBC-II**). This version was also based on the 16 bit Fujitsu controller but it had several improvements to the MBC-I. One of them is the current steering of the valve. It reduced heat production and improved control characteristics. The latest version Multibus controller type 3 (**MBC3**) is introduced in 2011. It is built around a 72MHz 32 bit NXP ARM controller. It has AD and DA controllers on board which makes it possible to measure noise free and control valves without delays. The internal control loop runs 6 times faster compared to the MBC-II therefore control stability has improved significantly. It also has several improved functions like reverse voltage protection, inrush current limitation and overvoltage protection.

MBC3 instruments can be recognised by the “MBC3” placed on lower left side of the instrument label (see example).



SNM1120XXXXA
P-702CV-21KA-AAD-22-V
500 In/h N2
9 bar (a) / 1 bar (a)
20 °C N.C. Control Valve

MBC3



1.3 REFERENCES TO OTHER APPLICABLE DOCUMENTS

Manuals and guides for digital instruments are modular. General instructions give information about the functioning and installation of instruments. Operational instructions explain the use of the digital instruments features and parameters. Field bus specific information explains the installation and use of the field bus installed on the instrument.

1.3.1 Manuals and user guides:

General instructions Instrument type based	Operational instructions	Field bus specific information
Document 9.17.022 Bronkhorst® General instructions digital Mass Flow / Pressure	Document 9.17.023 Operational instructions for digital multibus Mass Flow / Pressure instruments	Document 9.17.024 FLOW-BUS interface
Document 9.17.031 Bronkhorst® General instructions CORI-FLOW		Document 9.17.025 PROFIBUS DP interface
Document 9.17.050 Bronkhorst® General instructions mini CORI-FLOW		Document 9.17.026 DeviceNet interface
Document 9.17.044 Bronkhorst® General instructions digital LIQUI-FLOW L30		Document 9.17.035 Modbus interface
Document 9.17.104 / 9.17.105 Bronkhorst® Instruction manual MASS-STREAM D-6300		Document 9.17.027 RS232 interface with FLOW-BUS protocol
		Document 9.17.095 PROFINET interface
		Document 9.17.131 CANopen interface

1.3.2 Software tooling:

FlowPlot
FlowView
Flowfix
FlowDDE



All these documents can be found at:
<http://www.bronkhorst.com/en/downloads>

2 DIGITAL INSTRUMENT

2.1 GENERAL

A digital instrument of Bronkhorst® is a Mass Flow or Pressure Meter / Controller which is equipped with a digital electronic Multibus PC board. These electronics consist of a micro-controller with peripheral circuitry for measuring, controlling and communication. The flow/pressure signal is measured and digitized directly at the sensor and processed by means of the internal software (firmware). Measured and processed values can be output through the analog interface and through the digital communication line RS232 (and optional field bus interface). For controllers the setting for the actuator is calculated by the firmware. Setpoint can be given through the integrated analog interface or through the digital communication line. Digital instruments have many parameters for settings for signal processing, controlling and many extra features and therefore they have a wide range in use. Reading and changing of these settings is possible through field bus or RS232, except for measured value, setpoint and valve output, which is also possible through the analog interface. (Depending on parameter setting) See operating instructions of Readout and Control module or PC-program how to read/change parameter values of digital instruments.

2.2 BASIC DIAGRAM

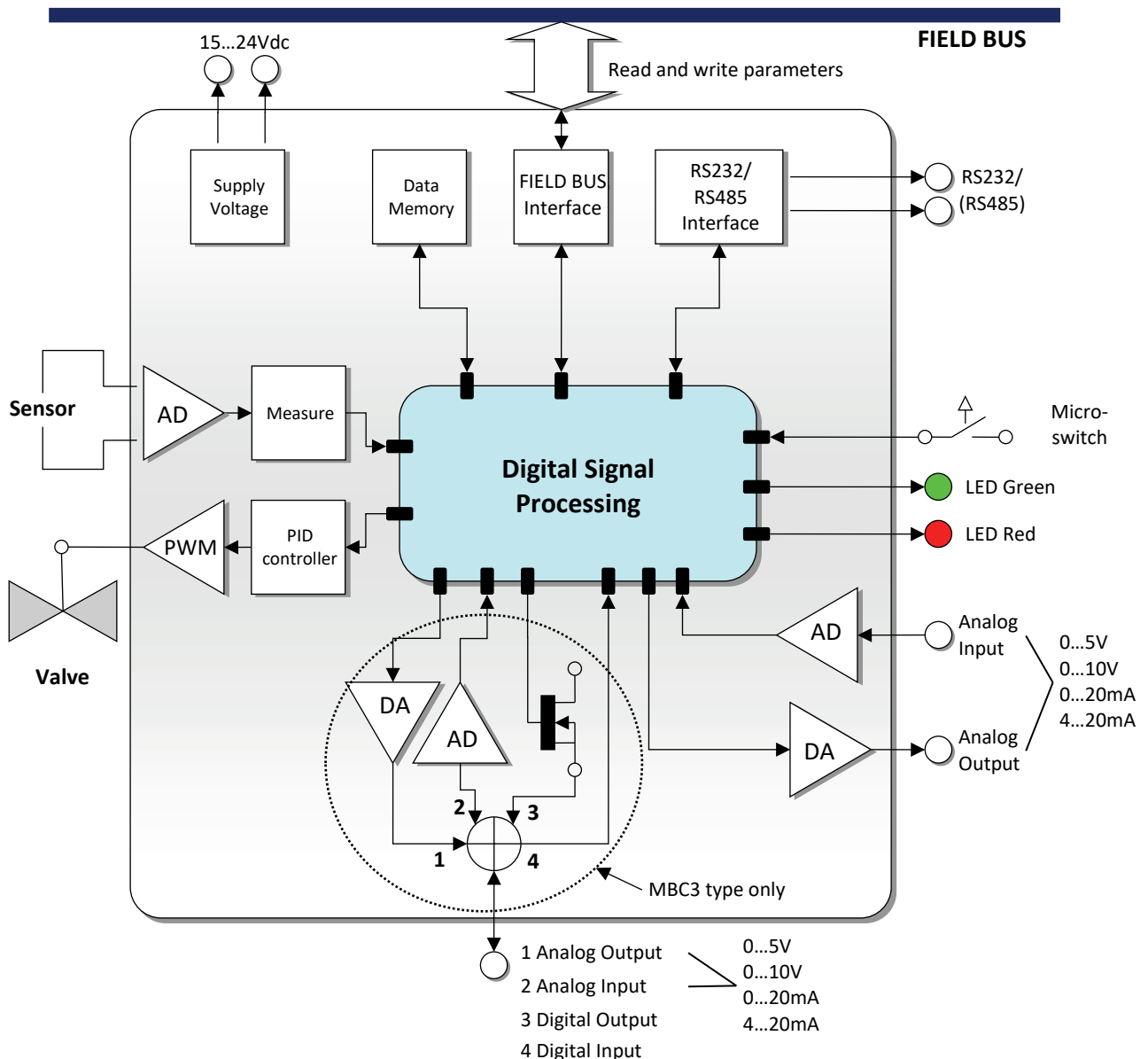

Digital instruments can be operated by means of:

1. Analog interface. (0...5Vdc/0...10Vdc/0...20mA/4...20mA)
2. RS232 interface (connected to COM-port by means of special cable (Default speed 38400 Baud))
3. FLOW-BUS
4. PROFIBUS DP
5. DeviceNet
6. Modbus
7. EtherCAT
8. PROFINET

Option 1 and 2 are always present on Multibus instruments. Option 3, 4, 5 and 6 are optional. Operation via analog interface, RS232 interface and an optional field bus can be performed at the same time. A special parameter called "control mode" indicates to which setpoint the controller should listen: analog or digital (via field bus or RS232). The RS232 interface behaves like a FLOW-BUS interface. When using more digital interfaces at the same time, reading can be done simultaneously without problems. When changing a parameter value, the last value send by an interface will be valid.

Also the micro push-button switch and the LED's on top of the instrument can be used for manual operation of some options.

- The green LED will indicate in what **mode** the instrument is active.
- The red LED will indicate **info / error / warning** situations.

2.3 MEASURE AND CONTROL FUNCTIONAL BLOCK DIAGRAM

The main part of a digital instrument is the measuring stage. The base is a highly accurate Analog to Digital converter. The measuring signal is then processed through a couple of stages as shown below. In general the path is: ADC scaling, filtering, linearization (look-up or polynomial), Differentiation (gas flow sensors only), display filtering. In case of a control system this signal is used to control a valve. The control loop consists of an enhanced PID controller (See the chapter "Control parameters").

Digital mass-flow measure / controller functional block diagram

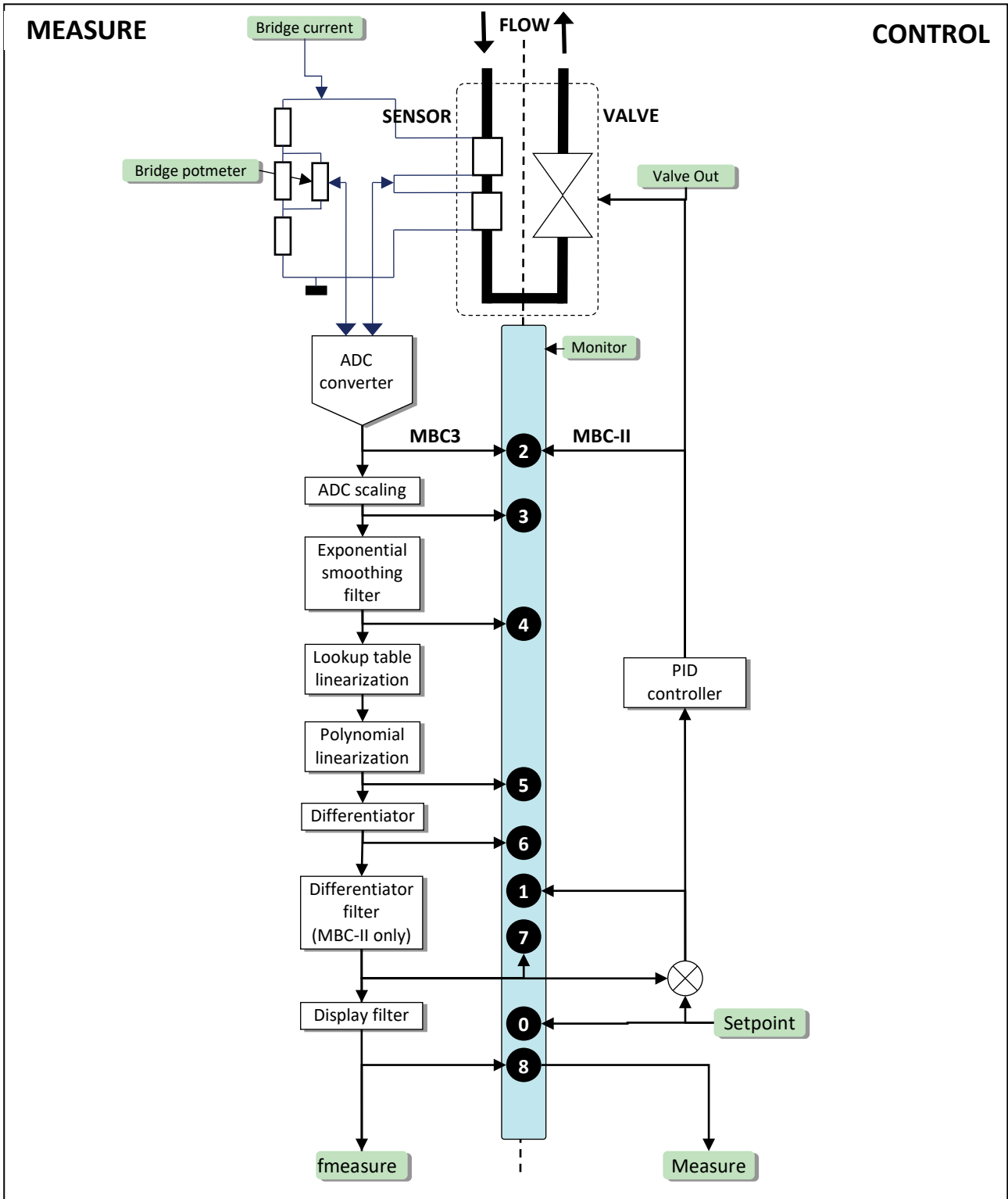

2.4 CALIBRATION WITH MATHEMATICAL FUNCTIONS

2.4.1 General information

Depending on instrument and sensor type an instrument output signal is calculated with one of the following mathematical methods:

- polynomial function
- look-up table (2 dimensions)
- look-up table with temperature compensation (3 dimensions)

2.4.2 Polynomial functions

By means of a few samples, a polynomial function can be obtained. After determining the polynomial function, the original calibration points and an infinite amount of values in between, can be calculated with high accuracy. In a system where pressure- and/or flow meters and -controllers should be readout and set with high accuracy, these polynomial functions often are used for approximation of their transfer function.

2.4.2.1 General form of a polynomial function

In mathematics, a polynomial is an expression of finite length constructed from variables (also known as in determinates) and constants. The general form of a polynomial function of the n-th degree is as follows:

$$y = a_0 + a_1 \cdot X + a_2 \cdot X^2 + a_3 \cdot X^3 + \dots + a_n \cdot X^n$$

n is a non-negative integer and 'a₀' to 'a_n' are polynomial constant coefficients. When you have 'n + 1' measure-points, they can be approximated by means of a 'nth' degree polynomial function.

2.4.2.2 Polynomial function of sensor signal

By means of a calibration at Bronkhorst® several measured calibration points will be used to obtain a polynomial function. The form of this function of the 3rd degree is:

$$Y = a + b \cdot X + c \cdot X^2 + d \cdot X^3$$

In which 'Y' is the normalized measured value (0-1) and 'X' is the value of the sensor signal. Characters 'a - d' are polynomial parameters, which can be obtained by a mathematical program. The polynomial parameters are calculated in such a way that the fit error between the calibration points and the polynomial function is minimized.

2.4.3 Look-up tables

It is also possible to linearize a sensor signal is using a so called look-up table. A look-up table is a table filled with calibration points. The embedded software inside the digital instrument calculates a continuous smooth function which fits exactly through these calibration points. Using this method it is possible to describe any monotone rising sensor signal curve with high accuracy.

2.4.4 General form of 2-dimensional look-up tables

The general form of a 2-dimensional look-up table is as follows:

index	X	Y
0	X ₀	Y ₀
1	X ₁	Y ₁
2	X ₂	Y ₂
3	X ₃	Y ₃
...
n	X _n	Y _n

In which 'Y' is the real flow value, 'X' is the value of the sensor signal and 'index' represents the position in the look-up table. A Bronkhorst® digital instrument can store look-up tables with a maximum of 21 calibration points.

2.4.5 Using mathematical functions at a digital instrument

Digital instruments are capable of storing 8 different fluid calibrations. Parameters for these calibrations are stored inside the instrument and can be read or changed through the field bus or the RS232 connection by means of a PC-program or a digital Readout and Control module. Factory calibration parameters are secured and cannot be changed unless you have special rights to do this. Selection of another fluid is part of operation and therefore not secured. Digital instruments will need at least 1 fluid set of calibration parameters for operation.

2.5 MULTI FLUID / MULTI RANGE INSTRUMENTS

2.5.1 General information

Multi Fluid / Multi Range (MFMR) instruments are calibrated for standard ranges which can easily be configured for other fluids and ranges. This applies for both Bronkhorst® and its customers. Changing fluid and range can be performed by means of a simple computer program through the RS232 connection of an instrument. The program can convert the primal calibration curve inside the instrument to the selected fluid and range.

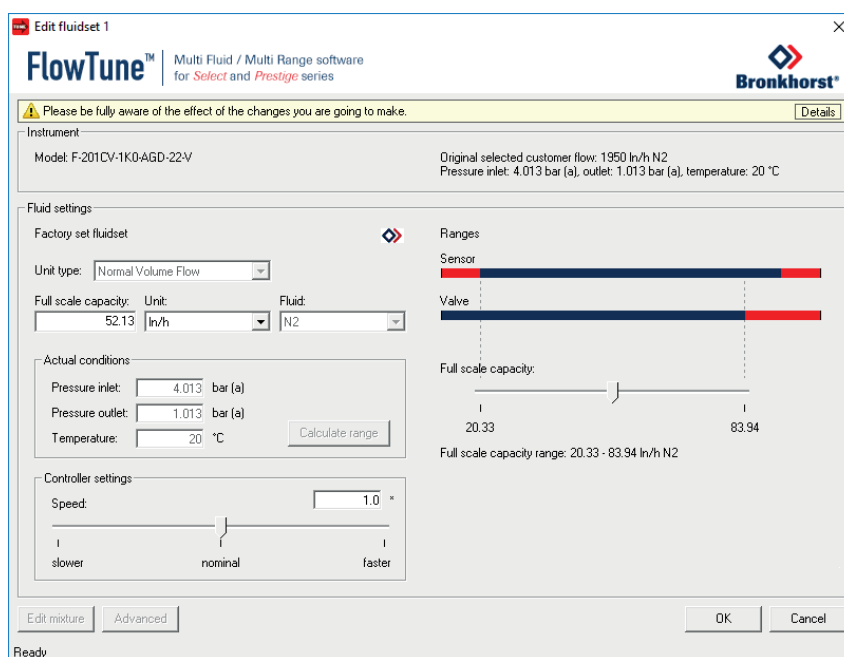

MFMR instruments can be identified by the text "MFMR" on the instruments identification.

2.5.2 Differences between traditional and MFMR instruments

In traditional digital instruments the parameters capacity, density, unit type, capacity unit etc. are static parameters. These parameters are used by, for example, read out units or PC-software to convert the measured value in percentage of the maximum output to a real value in a certain unit. However in MFMR instruments these parameters are dynamic.

Examples:

An instrument is configured for 2000 ml_n/min Air.

Changing the capacity unit from 'ml_n/min' to 'l_n/min' effects that the capacity automatically changes from '2000' to '2'. The 100% output is not affected.

Changing the capacity from '2000' to '1000' effects that the instruments full scale capacity (100% output) changes to 1000 ml_n/min. The instrument is reranged.

3 PARAMETERS AND PROPERTIES

3.1 GENERAL

Digital instruments consist of a microcontroller with several processes running simultaneously for:

- Measuring sensor value
- Reading analog input signal
- Digital signal processing
- Driving a valve
- Setting analog output signal
- Communication with the world outside

Each process needs its own specific parameters in order to function correctly. These parameter values are accessible through the available interface(s) to influence the process behavior (for instance Control behavior or alarm settings). These parameters can easily be controlled by end-users for more flexible use of the instruments. Bronkhorst® offers special software tooling for these purposes.

3.2 BRONKHORST® SOFTWARE

FlowDDE is software which allows users to communicate with digital instruments in a standard way. It uses the RS232 interface on the instrument which is linked to a computer with a standard Bronkhorst® cable. It converts the instrument parameters to DDE commands. DDE (Dynamic Data Exchange) is a technology for communication between multiple applications under Microsoft Windows.

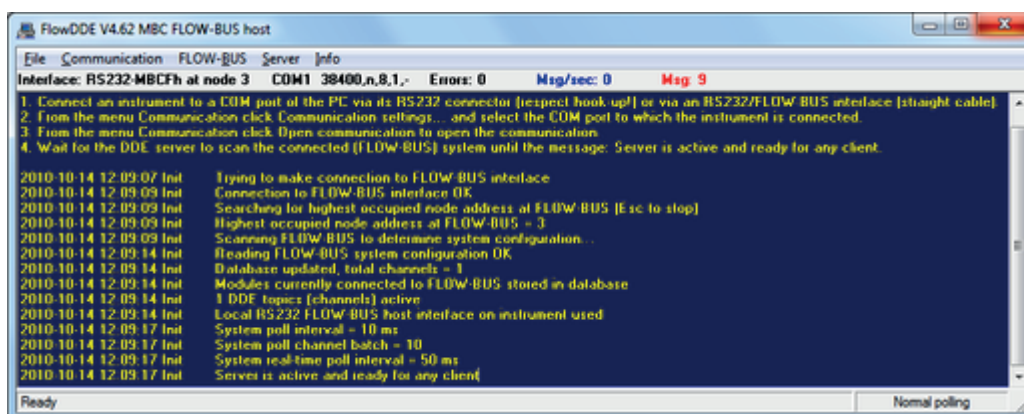

FlowView and FlowPlot use FlowDDE as a server. In short:

FlowView :Windows application for the readout and/or control of 12 instruments (default), configurable up to 99 instruments.

FlowPlot :Windows application for monitoring and optimizing. (Value versus time on screen)

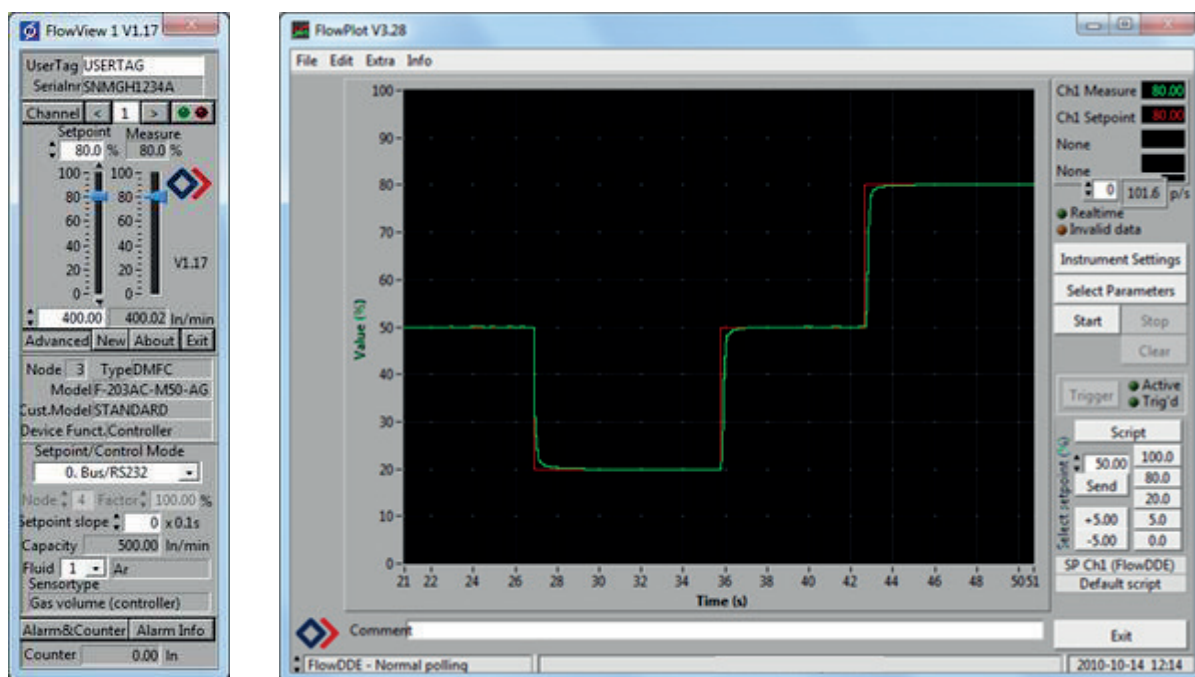

These programs are on the support CD or can be downloaded from:
http://www.bronkhorst.com/en/products/accessories/software_tools/

End-users are also free to use their own software using either:

- FlowDDE : DDE-server for data exchange with Microsoft Windows applications
- FLOWB32.DLL : Dynamic Link Library for Microsoft Windows applications
- RS232 interface : Protocol for instructions with ASCII HEX or Binary telegrams

3.3 PARAMETER USE

In general each parameter has its own properties, like data-type, size, reading/writing allowance, security.

Parameters can be protected in general:

- Parameters used for operation of instruments are not secured (read / write is allowed). (e.g.: measure, setpoint, control mode, setpoint slope, fluid number, alarm and counter)
- Parameter for settings and configuration are secured (reading is allowed/ writing is not allowed). (e.g.: calibration settings, controller settings, identification, network/field bus settings)

Parameters for settings are secured. They can be read-out, but cannot be changed without knowledge of special key-parameters and knowledge of the instrument.

Reading/changing parameter values via FlowDDE offers the user a different interface to the instrument. Besides the server name: 'FlowDDE' or 'FlowDDE2' there is only need of:

- topic, used for channel number: 'C(X)' (x = channel number)
- item, used for parameter number: 'P(Y)' (y = parameter number)

A DDE parameter number is a unique number in a special FlowDDE instruments/parameter database and not the same as the parameter number from the process on an instrument. Node address and process number will be translated by FlowDDE to a channel number.

When not using FlowDDE for communication with the instrument, each parameter value needs:

- node address of instrument on FLOW-BUS
- process number on instrument
- parameter number on instrument



Document "917027--Manual RS232 interface" explains in more detail the use of RS232 communication
 This document can be found at:
http://www.bronkhorst.com/en/downloads/instruction_manuals/

Example of a parameter and the explanation:

	Data Type	Range	read/write	Secured	DDE	Proc/par
Valve output	unsigned long	0...16777215	RW	N	55	114 1

unsigned long = one of the data types below.

Unsigned char	1 byte integer
Unsigned int	2 bytes integer, MSB first
Unsigned long	4 bytes integer, MSB first
Float	4 bytes IEEE 32-bit single precision numbers, MSB first
Unsigned char []	array of characters (string)

RW = R - parameter can be read, W – parameter can be written.
Secured =  Y=Parameter is secured. N= Parameter not secured.
0...16777215 = Parameter range.
DDEpar. = 55 = FlowDDE parameter number
Proc. = 114 = Process number
Par. = 1 = process parameter number

Another example is:

	Data Type	Range	read/write	Secured	DDE	Proc/par
Fluid name	unsigned char[10]	a...Z, 0...9	RW	 Y	25	1 17

unsigned char[10] = Data type Unsigned char[], array of characters. [10] = number of characters.
RW = R - parameter can be read, W – parameter can be written.
Secured =  Y=Parameter is secured. N= Parameter not secured.
a...Z = characters which can be used in the string
0...9 = numbers which can be used in the string
DDEpar. = 25 = FlowDDE parameter number
Proc. = 1 = Process number
Par. = 17 = process parameter number



secured parameter:
 To enable secured parameter, see chapter 9 SPECIAL PARAMETERS 9.2 INITRESET.



More information can be found in the manual "917030 Manual FlowPlot"
 This document can be found at:
http://www.bronkhorst.com/en/downloads/instruction_manuals/

4 NORMAL OPERATION PARAMETERS

	Data Type	Range	read/write	Secured	DDE	Proc/par
4.1 MEASURE UNIPOLAIR	unsigned int	0...41942	R	N	8	1/0
4.2 MEASURE BIPOLAIR	unsigned int	0...65535	R	N	8	1/0
4.3 FMEASURE	float	-3.40282E+38 ... 3.40282E+38	R	N	205	33/0

Depending on the type of instrument, measured value indicates the amount of mass flow or pressure metered by the instrument. Sensor signals at digital instruments will be digitized at the sensor bridge by means of highly accurate AD-converters. Digitized signals will be internally processed by the microcontroller using floating point notation. The sensor signal will be differentiated, linearized and filtered.

At the digital output measured values can be presented in three ways:

1. For **Unipolair** mode the signal of 0...100% will be presented in a range of 0...32000.
For the instruments, maximum signal to be expected is 131.07 %, which is: 41942.

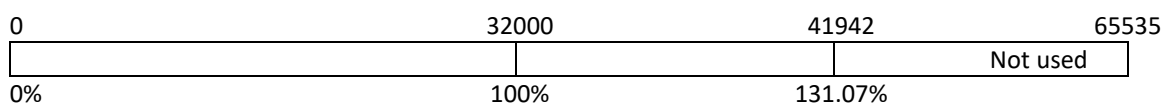

2. For **Bipolair** mode the signal of 0...100% will be presented in a range of 0...32000.
Maximum signal is 131.07 %, which is: 41942, minimum signal is -73.73 %, which is 41943

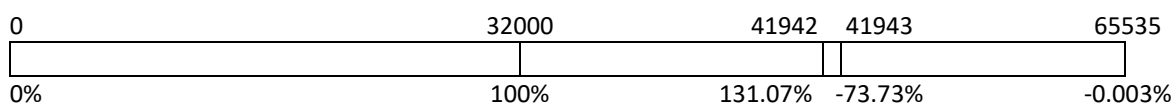

3. **Fmeasure** is a different parameter as Measure. It represents the internal floating point version of the variable measure as mentioned before.

The users will read-out the measured value in the capacity and capacity unit for which the instrument has been calibrated. These settings depend on variables: capacity, capacity unit, sensor type and capacity 0%. Fmeasure is a read-only float on (FLOW-BUS) proc 33, par 0.

Value is calculated as follows:

$$\text{in text} \quad \text{fmeasure} = \left(\frac{\text{measure}}{32000} * (\text{capacity100\%} - \text{capacity0\%}) \right) + \text{capacity0\%}$$

4.4	SETPOINT	unsigned int	0...32000	RW	N	9	1/1
4.5	FSETPOINT	float	1e-10...1e+10	RW	N	206	33/3

Setpoint of the instrument can be operated by two parameters at the same time:

- Setpoint** is used to tell the PID controller in the instrument what the wanted amount of mass flow or pressure is. Signals are in the same range as the measured value, only setpoint is limited between 0 and 100 %. Setpoint can be given either via optional field bus or RS232 or via the analog interface. The parameter control mode selects the active setpoint for the controller. See that paragraph for more detailed information.
- With the use of parameter Fmeasure, also Fsetpoint is often needed. This parameter is R/W as variable in FLOW-BUS proc33, par3. Fsetpoint is a float (in the capacity in which the instrument was calibrated, see also Fmeasure). The last received setpoint by the instrument will be valid. It is not advised to use setpoint and Fsetpoint at the same time.

Relation between setpoint and Fsetpoint is calculated as follows:

in text

$$\text{setpoint} = \left(\frac{\text{fsetpoint} - \text{capacity0\%}}{\text{capacity} - \text{capacity0\%}} \right) \bullet 32000$$



Reading back actual values of Fsetpoint is also possible. When a value has been send to proc1, par1 (integer setpoint), then this will be converted to the float setpoint for direct reading in the right capacity and unit

4.6	SETPOINT MONITOR MODE	unsigned char	0...255	RW	Y	329	115/23
------------	------------------------------	---------------	---------	----	---	-----	--------

This parameter makes it possible to visualize the internal setpoint value.

Value	Description
0	Setpoint
1	Internal setpoint after Setpoint Exponential Smoothing filter
2	Internal setpoint after slope function

4.7	SETPOINT EXPONENTIAL SMOOTHING FILTER	float	0...1	RW	Y	73	117/3
------------	--	-------	-------	----	---	----	-------

This factor is used for filtering the setpoint before it is further processed.

It filters according the following formula:

$$Y_0 = x_0 \bullet \text{Setpoint exp. filter} + y_1 \bullet (1 - \text{Setpoint exp. filter})$$

Default value = 1 (off)

This filter is in the control loop so it affects the response time.



*For MBC-II type of instruments this parameter affects the analog setpoint signal.
For MBC3 type of instruments this parameter affects both analog and digital setpoint signals.*

4.8	SETPOINT SLOPE	unsigned int	0...30000	RW	N	10	1/2																																																																																																												
<p>Digital instruments can establish a smooth setpoint control using the setpoint slope time. The setpoint will be linear increased in time from old setpoint to new setpoint value. A value between 0 and 3000 seconds, with a resolution of 0.1 seconds, can be given to set the time for the integrator on the setpoint signal.</p> <p>Setpoint will reach its end value after:</p> $\left(\frac{\text{newsp} - \text{oldsp}}{100} \right) \bullet \text{slope} = \text{seconds}$ <p>Sample; When slope = 10 seconds how long will it take to go from 20% to 80%?</p> $\left(\frac{80\% - 20\%}{100\%} \right) \bullet 10 = 6 \text{ seconds}$																																																																																																																			
4.9	ANALOG INPUT	unsigned int	0...65535	R	N	11	1/3																																																																																																												
<p>Depending on the analog mode, 0...5Vdc / 0...10Vdc / 0...20mA / 4...20mA is converted to 0...32000. Analog input signals (digitized) are in the same range as measured values (0...32000 = 0...100%). This input can be used to give setpoint or slave factor, depending on the value of control mode.</p>																																																																																																																			
4.10	CONTROL MODE	unsigned char	0...255	RW	N	12	1/4																																																																																																												
<p>For switching between different functions of a digital meter or controller several modes are available.</p> <table border="1"> <thead> <tr> <th></th> <th>Mode</th> <th>Instrument action</th> <th>Setpoint source</th> <th>Master source</th> <th>Slave factor</th> </tr> </thead> <tbody> <tr> <td>0</td> <td>BUS/RS232</td> <td>Controlling</td> <td>BUS/RS232</td> <td></td> <td></td> </tr> <tr> <td>1</td> <td>Analog input</td> <td>Controlling</td> <td>analog input</td> <td></td> <td></td> </tr> <tr> <td>2</td> <td>FLOW-BUS slave</td> <td>controlling as slave from other instrument on the bus</td> <td>FLOW-BUS * slave factor /100%</td> <td>FLOW-BUS</td> <td>slave factor (proc33,par 1)</td> </tr> <tr> <td>3</td> <td>Valve close</td> <td>close valve</td> <td></td> <td></td> <td></td> </tr> <tr> <td>4</td> <td>Controller idle</td> <td>stand-by on BUS/RS232 controlling is stopped / Valve Out freezes in current position</td> <td></td> <td></td> <td></td> </tr> <tr> <td>5</td> <td>Testing mode</td> <td>testing enabled (factory only)</td> <td></td> <td></td> <td></td> </tr> <tr> <td>6</td> <td>Tuning mode</td> <td>tuning enabled (factory only)</td> <td></td> <td></td> <td></td> </tr> <tr> <td>7</td> <td>Setpoint 100%</td> <td>controlling on 100%</td> <td>100%</td> <td></td> <td></td> </tr> <tr> <td>8</td> <td>Valve fully open</td> <td>purge valve</td> <td></td> <td></td> <td></td> </tr> <tr> <td>9</td> <td>Calibration mode</td> <td>calibration enabled (factory only)</td> <td></td> <td></td> <td></td> </tr> <tr> <td>10</td> <td>Analog slave</td> <td>controlling as slave from other instrument on analog input</td> <td>Analog input * slave factor /100%</td> <td>analog input</td> <td>proc33,par 1 (slave factor)</td> </tr> <tr> <td>12</td> <td>setpoint 0%</td> <td>controlling on 0%</td> <td>0%</td> <td></td> <td></td> </tr> <tr> <td>13</td> <td>FLOW-BUS analog slave</td> <td>controlling as slave from other instrument on bus, slave factor is set with signal on analog input</td> <td>FLOW-BUS * analog input * slave factor /100%</td> <td>FLOW-BUS * analog input</td> <td>analog input</td> </tr> <tr> <td>18</td> <td>RS232</td> <td>Controlling (safe state deactivated)</td> <td>BUS/RS232</td> <td></td> <td></td> </tr> <tr> <td>20</td> <td>valve steering (valve = setpoint)</td> <td>Setpoint is redirected directly to Valve Out with the controller idle</td> <td></td> <td></td> <td></td> </tr> <tr> <td>21</td> <td>analog valve steering (valve = analog input)</td> <td>Analog input is redirected directly to Valve Out with the controller idle</td> <td></td> <td></td> <td></td> </tr> <tr> <td>22</td> <td>valve safe state</td> <td>Force instrument in safe state</td> <td></td> <td></td> <td></td> </tr> </tbody> </table> <p> Analog input= external input= pin 3 on DB 9 connector. BUS = any available field bus</p> <p>At power-up the control mode will be set by the jumper or dip switch setting on the PC-board of the instrument (only for the control mode values 0, 1, 9 or 18). If the actual control mode is not equal to 0, 1, 9 or 18, it will not be overruled by jumper or dip switch setting on the PC-board of the instrument. For more information see parameter IOStatus.</p>									Mode	Instrument action	Setpoint source	Master source	Slave factor	0	BUS/RS232	Controlling	BUS/RS232			1	Analog input	Controlling	analog input			2	FLOW-BUS slave	controlling as slave from other instrument on the bus	FLOW-BUS * slave factor /100%	FLOW-BUS	slave factor (proc33,par 1)	3	Valve close	close valve				4	Controller idle	stand-by on BUS/RS232 controlling is stopped / Valve Out freezes in current position				5	Testing mode	testing enabled (factory only)				6	Tuning mode	tuning enabled (factory only)				7	Setpoint 100%	controlling on 100%	100%			8	Valve fully open	purge valve				9	Calibration mode	calibration enabled (factory only)				10	Analog slave	controlling as slave from other instrument on analog input	Analog input * slave factor /100%	analog input	proc33,par 1 (slave factor)	12	setpoint 0%	controlling on 0%	0%			13	FLOW-BUS analog slave	controlling as slave from other instrument on bus, slave factor is set with signal on analog input	FLOW-BUS * analog input * slave factor /100%	FLOW-BUS * analog input	analog input	18	RS232	Controlling (safe state deactivated)	BUS/RS232			20	valve steering (valve = setpoint)	Setpoint is redirected directly to Valve Out with the controller idle				21	analog valve steering (valve = analog input)	Analog input is redirected directly to Valve Out with the controller idle				22	valve safe state	Force instrument in safe state			
	Mode	Instrument action	Setpoint source	Master source	Slave factor																																																																																																														
0	BUS/RS232	Controlling	BUS/RS232																																																																																																																
1	Analog input	Controlling	analog input																																																																																																																
2	FLOW-BUS slave	controlling as slave from other instrument on the bus	FLOW-BUS * slave factor /100%	FLOW-BUS	slave factor (proc33,par 1)																																																																																																														
3	Valve close	close valve																																																																																																																	
4	Controller idle	stand-by on BUS/RS232 controlling is stopped / Valve Out freezes in current position																																																																																																																	
5	Testing mode	testing enabled (factory only)																																																																																																																	
6	Tuning mode	tuning enabled (factory only)																																																																																																																	
7	Setpoint 100%	controlling on 100%	100%																																																																																																																
8	Valve fully open	purge valve																																																																																																																	
9	Calibration mode	calibration enabled (factory only)																																																																																																																	
10	Analog slave	controlling as slave from other instrument on analog input	Analog input * slave factor /100%	analog input	proc33,par 1 (slave factor)																																																																																																														
12	setpoint 0%	controlling on 0%	0%																																																																																																																
13	FLOW-BUS analog slave	controlling as slave from other instrument on bus, slave factor is set with signal on analog input	FLOW-BUS * analog input * slave factor /100%	FLOW-BUS * analog input	analog input																																																																																																														
18	RS232	Controlling (safe state deactivated)	BUS/RS232																																																																																																																
20	valve steering (valve = setpoint)	Setpoint is redirected directly to Valve Out with the controller idle																																																																																																																	
21	analog valve steering (valve = analog input)	Analog input is redirected directly to Valve Out with the controller idle																																																																																																																	
22	valve safe state	Force instrument in safe state																																																																																																																	

4.10.1 Dual interface operation

When operating a controller (reading measured value and sending setpoint) for proper operation it is important that the controller gets its setpoint from the right source. Setpoints may come from different sources: analog input, field bus interface, RS232 interface or may be overruled by close valve or open valve (purge) commands. Therefore it is important to know what the setpoint source of the controller is. This can be set by means of parameter control mode (DDE parameter 12).

In some cases it is possible that the setpoint may come from 2 sources at the same time. The last setpoint send will be valid and send to the controller. This is the case in control mode = 0, when setpoints may come through any field bus interface or RS232. However, there could be situations where control over the instrument seems impossible. This is the case when the instrument comes into a safe-state e.g. when field bus communication is disturbed or disconnected. The valve will be forced to a safe state automatically: closed (NC) or fully open (NO).

In case you want to get control back via RS232 operation, you have to change the control mode. When control mode gets value 18, safe state will be overruled and sending setpoints via RS232 interface will have effect on the controller again. 'Control Mode' value 18 will be lost after power off and power on of the instrument.

4.10.2 Tuning, test and calibration mode

These are special modes to prepare the instrument for either a tuning, test or calibration action. These modes are used by Bronkhorst® service personnel only and are not meant for customer use.

4.11 SLAVE FACTOR	float	0...500	RW	N	139	33/1
--------------------------	-------	---------	----	---	-----	------

Depending on the Setpoint/control mode a slave factor can be set.

In master/slave or ratio control the setpoint of an instrument is related to the output signal of another instrument.

$$\text{setpoint}_{(\text{slave})} = \frac{\text{Outputsignal}_{(\text{master})} \bullet \text{slave factor}}{100\%}$$

Digital instruments offer possibilities for master/slave control via the FLOW-BUS. The output value of any instrument connected to the FLOW-BUS is automatically available to all other instruments (without extra wiring). When master/slave control is wanted the instrument can be put in control mode 2 or 13, depending on how the slave factor should be set (see table above). Through FLOW-BUS an instrument can be told that it should be a slave, who should be its master (DDEpar. 158 'Master Node') and what should be the slave factor to follow the master with. It is possible to have more masters and more slaves in one system. A slave can also be a master itself for other instruments.



*These options are available for FLOW-BUS or RS232 instruments only.
Output signals from master can be received via FLOW-BUS only.
Slave factors can also be changed via RS232.*



Master/slave is meant here for controlling purposes and has nothing to do with master and slave behavior on field bus networks.

4.12 FLUID NUMBER	unsigned char	0...7	RW	N	24	1/16
--------------------------	---------------	-------	----	---	----	------

Fluid number is a pointer to the set of calibration parameters. Each selectable fluid has its own set of calibration parameter values. Fluid number is an unsigned char parameter (DDEpar. 24 'Fluid number') in the range of 0...7, where 0 = fluid1 and 7 = fluid8. Up to 8 fluids can be stored in one instrument. Default value = 0 (fluid 1).

4.13 FLUID NAME	unsigned char[10]	a...z / 0...9	RW	Y	25	1/17
------------------------	-------------------	---------------	----	---	----	------

Fluid name consists of the name of the fluid of the actual selected fluid number. Up to 10 characters are available for storage of this name. This parameter is secured and read-only for normal users (it is written during calibration at the factory). Default value is "Air".

4.14 VALVE OUTPUT	unsigned long	0...16777215	RW	N	55	114/1																									
This parameter is the signal coming out of the controller, going to the DAC for driving the valve. 0...16777215 corresponds with approximately 0...300mAdc. Maximum output voltage is the supply voltage and therefore in practice 300 mAdc may not be reached.																															
4.15 TEMPERATURE	float	-250...500	RW	N	142	33/7																									
In MBC3 type of instruments the temperature surrounding the sensor is shown. For (mini) CORI-FLOW type of instruments this parameter shows the temperature of the tubes. It is not used in other instruments.																															
4.16 ACTUAL DENSITY	float	-3.40282E+38 ... 3.40282E+38	R	N	270	116/15																									
This parameter shows the Actual Density measured by the (mini) CORI-FLOW. It is not used in other instruments.																															
4.17 SENSOR TYPE	unsigned char	0...255	RW	 Y	22	1/14																									
Unsigned char used to select proper set of units for certain sensor, together with Counter unit (MBC-II type). Default setting is 3.																															
<table border="1"> <thead> <tr> <th>Value</th> <th>Description</th> <th>Controller/Sensor</th> </tr> </thead> <tbody> <tr> <td>0</td> <td>pressure (no counting allowed)</td> <td rowspan="5">Controller</td> </tr> <tr> <td>1</td> <td>liquid volume</td> </tr> <tr> <td>2</td> <td>liquid/gas mass</td> </tr> <tr> <td>3</td> <td>gas volume</td> </tr> <tr> <td>4</td> <td>other sensor type (no counting allowed)</td> </tr> <tr> <td>128</td> <td>pressure (no counting allowed)</td> <td rowspan="5">Sensor</td> </tr> <tr> <td>129</td> <td>liquid volume</td> </tr> <tr> <td>130</td> <td>liquid/gas mass</td> </tr> <tr> <td>131</td> <td>gas volume</td> </tr> <tr> <td>132</td> <td>other sensor type (no counting allowed)</td> </tr> </tbody> </table>							Value	Description	Controller/Sensor	0	pressure (no counting allowed)	Controller	1	liquid volume	2	liquid/gas mass	3	gas volume	4	other sensor type (no counting allowed)	128	pressure (no counting allowed)	Sensor	129	liquid volume	130	liquid/gas mass	131	gas volume	132	other sensor type (no counting allowed)
Value	Description	Controller/Sensor																													
0	pressure (no counting allowed)	Controller																													
1	liquid volume																														
2	liquid/gas mass																														
3	gas volume																														
4	other sensor type (no counting allowed)																														
128	pressure (no counting allowed)	Sensor																													
129	liquid volume																														
130	liquid/gas mass																														
131	gas volume																														
132	other sensor type (no counting allowed)																														
4.18 CAPACITY 100%	float	1e-10...1e+10	RW	 Y	21	1/13																									
Capacity is the maximum value (span) at 100% for direct reading in readout units. The readout unit will be determined by the capacity unit index / string. For each fluid (number) capacity will be stored separately.																															
4.19 CAPACITY 0%	float	1e-10...1e+10	RW	 Y	183	33/22																									
This is the capacity zero point (offset) for direct reading in readout units. The readout unit will be determined by the capacity unit index / string. For each fluid (number) capacity will be stored separately.																															

4.20 CAPACITY UNIT INDEX	unsigned char	0...4	RW	 Y	23	1/15
---------------------------------	---------------	-------	----	---	----	------



This parameter gives access to the limited unit table which is available for MBC-II and MBC3 type of instruments.

Capacity unit index is a pointer to select an actual readout unit (see list below). For FLOW-BUS instruments all capacity units are available for direct reading. Other field busses (eg. DeviceNet) are limited in options for direct reading facilities.

		capacity unit index (limited unit table)									
		0	1	2	3	4	5	6	7	8	9
Sensor Type	0	bar	mbar	psi	kPa	cmH2O	cmHg	atm	kgf/cm2		
	1	l/min	ml/h	ml/min	l/h	mm3/s	cm3/min				
	2	kg/h	kg/min	kg/s	g/h	g/min	g/s	mg/h	mg/min	mg/s	
	3	ln/min	mln/h	mln/min	ln/h	m3n/h	mls/min	mls/h	ls/min	ls/h	m3s/h
	4	usrtype	usrtype	usrtype							

name	description
sensor type	Indicator for type of sensor in instrument in relation with a list of units for direct reading
capacity unit index	Points to the capacity unit for direct reading in list of available units

Example:

If you want to readout your instrument in ln/min, then make sure parameter "sensor type" is set to value 3 and parameter "capacity unit index" is set to value 0. By means of parameter "capacity unit" the unit string can be read-back as a 7 character string.

4.21 CAPACITY UNIT	unsigned char[7]	see table	RW	Y/N	129	1/31
---------------------------	------------------	-----------	----	-----	-----	------



This parameter gives access to the extended unit table which is available for MBC3 type of instruments only.



*For MBC-II type of instruments this parameter can only be read.
Only if sensor type = 4 (other sensor type) this parameter can be written*



*For MBC3 type of instruments this parameter can be read and written.
The easiest way to change a unit in the MBC3 type of instrument is to fill in the unit needed from the table below in capacity unit.*

The "Capacity unit" displays the unit name set by "Capacity unit index". A valid "Capacity unit" (for example l/min) can also be entered here which changes the "Capacity unit index". In MBC3 type of instruments the parameter is not secured.

Extended unit table										
Pressure A	mbar(a)	bar(a)	gf/cm2a	kgf/cma	psi(a)	torr(a)	Pa(a)	hPa(a)	kPa(a)	MPa(a)
	atm(a)	mmH2O(a)	cmH2Oa	mH2O(a)	"H2O(a)	ftH2Oa	mmHg(a)	cmHg(a)	"Hg(a)	
Pressure G	mbar(g)	bar(g)	gf/cm2g	kgf/cm2g	psi(g)	torr(g)	Pa(g)	hPa(g)	kPa(g)	MPa(g)
	atm(g)	mmH2Og	cmH2Og	mH2O(g)	"H2O(g)	ftH2Og	mmHg(g)	cmHg(g)	"Hg(g)	
Pressure D	mbar(d)	bar(d)	gf/cm2d	kgf/cmd	psi(d)	torr(d)	Pa(d)	hPa(d)	kPa(d)	MPa(d)
	atm(d)	mmH2Od	cmH2Od	mH2O(d)	"H2O(d)	ftH2Od	mmHg(d)	cmHg(d)	"Hg(d)	
Mass Flow	ug/h	ug/min	ug/s	mg/h	mg/min	mg/s	g/h	g/min	g/s	kg/h
	kg/min	kg/s								
(Custom) Volume Flow	ul/h	ul/min	ul/s	ml/h	ml/min	ml/s	l/h	l/min	l/s	cc/h
	cc/min	cc/s	mm3/h	mm3/m	mm3/s	cm3/h	cm3/min	cm3/s	m3/h	m3/min
Normal Volume Flow	m3/s	cfh	cfm	cfs						
	uln/h	uln/min	uln/s	mln/h	mln/min	mln/s	ln/h	ln/min	ln/s	ccn/h
Standard Volume Flow	ccn/min	ccn/s	mm3n/h	mm3n/m	mm3n/s	cm3n/h	cm3n/m	cm3n/s	m3n/h	m3n/min
	m3n/s	scfh	scfm	scfs	sccm	slm				
Standard Volume Flow	uls/h	uls/min	uls/s	mls/h	mls/min	mls/s	ls/h	ls/min	ls/s	ccs/h
	ccs/min	ccs/s	mm3s/h	mm3s/m	mm3s/s	cm3s/h	cm3s/m	cm3s/s	m3s/h	m3s/min
	m3s/s									



Due to compatibility the maximum string length is limited to 7 characters. Therefore unit names may be truncated. For instance mm3n/m means mm3n/min.

5 CONTROL PARAMETERS



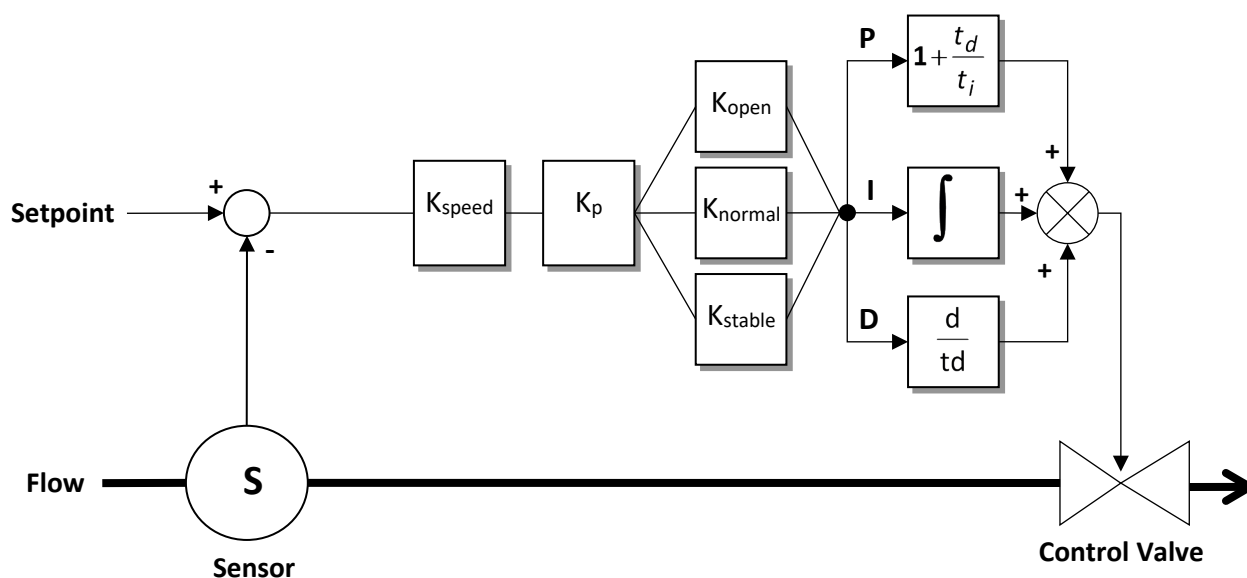

The controlling algorithm for the valve handled by the micro-controller consists of several parameters which can be set via the BUS/RS232. Although many parameters could be accessed via BUS/RS232, Bronkhorst® advises not to change these parameters because during manufacturing they have got optimal values for their purposes. Changing of controller settings should be performed by or under supervision from trained service personnel only.

The picture below shows the basic controller diagram of the digital instrument. It consists of a standard PID controller with a number of add-ons.



Basically, when a faster or slower controller response is needed, only the controller speed (Kspeed) or PID-Kp has to be changed.

	Data Type	Range	read/write	Secured	DDE	Proc/par
5.1 PID-KP	float	0...1E+10	RW	Y	167	114/21
PID controller response, proportional action, multiplication factor.						
5.2 PID-Ti	float	0...1E+10	RW	Y	168	114/22
PID controller response, integration action in seconds.						
5.3 PID-Td	float	0...1E+10	RW	Y	169	114/23
PID controller response, differentiation action in seconds.						
5.4 CONTROLLER SPEED (Kspeed)	float	0...3.40282E+38	RW	Y	254	114/30
This parameter is the controller speed factor. PID-Kp is multiplied by this factor.						
5.5 OPEN FROM ZERO RESPONSE	unsigned char	0...255	RW	Y	165	114/18
Controller response when starting-up from 0% (K_{open} , K_p multiplication factor when valve opens). Value 128 is default and means: no correction. Otherwise controller speed will be adjusted as follows:						
$\text{New response} = \text{old response} * 1.05^{(128 - \text{Open from Zero})}$						

5.6	NORMAL STEP RESPONSE	unsigned char	0...255	RW	 Y	72	114/5										
Controller response during normal control (K_{normal} , K_p multiplication factor at setpoint step)																	
New response = old response * 1.05 ^(128-Normal Step)																	
5.7	STABLE RESPONSE	unsigned char	0...255	RW	 Y	141	114/17										
Controller response when controller is stable (K_{stable} , K_p multiplication factor within band of 2%)																	
New response = old response * 1.05 ^(128-Stable response)																	
5.8	SENSOR DIFFERENTIATOR UP	float	0...1E+10	RW	 Y	51	1/12										
Sensor time constant (upwards).																	
5.9	SENSOR DIFFERENTIATOR DOWN	float	0...1E+10	RW	 Y	50	1/11										
Sensor time constant (downwards).																	
5.10	SENSOR EXPONENTIAL SMOOTHING FILTER	float	0...1	RW	 Y	74	117/4										
This factor is used for filtering the signal coming from the sensor circuitry before it is further processed.																	
It filters according the following formula: $Y_0 = x_0 \bullet \text{Sensor exp. filter} + y_1 \bullet (1 - \text{Sensor exp. filter})$																	
For EL-FLOW types of instruments it will be the “slow” (not differentiated), non-linearized sensor signal. Only in case of a noisy sensor signal this value will have another value than 1.0. Advise: do not give a value much lower than 0.8, otherwise it would slow down sensor response too much. Best setting: 1.0.																	
For (mini) CORI-FLOW instruments it will influence the amount of averaging of the “bare” values. The smaller this value gets, the slower a (mini) CORI-FLOW instrument will get a sensor signal, but less noise will be on the signal.																	
<table border="1" style="margin-left: auto; margin-right: auto;"> <thead> <tr> <th>Response</th> <th>Factor setting</th> </tr> </thead> <tbody> <tr> <td>Slow</td> <td>0.05</td> </tr> <tr> <td>Normal</td> <td>0.1</td> </tr> <tr> <td>Fast</td> <td>0.2</td> </tr> <tr> <td>Very fast</td> <td>0.5...1.0 (not advised)</td> </tr> </tbody> </table>								Response	Factor setting	Slow	0.05	Normal	0.1	Fast	0.2	Very fast	0.5...1.0 (not advised)
Response	Factor setting																
Slow	0.05																
Normal	0.1																
Fast	0.2																
Very fast	0.5...1.0 (not advised)																
This filter is in the control loop so it affects the response time.																	

5.11 VALVE SAFE STATE	Unsigned char	0...255	RW	N	301	115/31
------------------------------	---------------	---------	----	---	-----	--------

The controller module will go to a safe state in the following situations:

- If bus communication is lost and control mode = 0, 2, 3, 4, 7, 8, 10, 12, 13 or 20.
(DeviceNet, PROFIBUS DP, PROFINET and EtherCAT only)
- if initreset = 73
- if control mode = 22 (new safe state control mode)

The safe state will not function if the bus configuration mode is activated.

In fail safe state the green LED will be blinking (0.1 sec on, 2 sec off).

The valve will react to the failsafe state according to the table below.

Decimal value	Description
0	Deactivate valve (0mA)
1	Activate valve (max current)
2	Close valve
3	Open valve
4	Hold valve in current position
5	Hold valve at safe value



If Initreset = 73 the failsafe state mode will always be "hold valve in current position"

"Hold valve at safe value" can only be used with DeviceNet instruments.

6 ALARM / STATUS PARAMETERS

6.1 GENERAL

Bronkhorst® digital instruments have a build in alarm function. It is used to indicate several types of alarms:

- System errors
- System warnings
- Min/max alarms
- Response alarms
- Batch alarm
- Master slave alarms
- Master slave alarms

The alarm can be read out using parameter alarm info. After an alarm a setpoint change can be set. This means the setpoint will go to the set value after an alarm occurs. A delay can be set to prevent reaction to glitches in measurement or power. How an alarm can be reset is controlled by the parameter "reset alarm enable". It can bit-wise be set to automatic, reset, external or keyboard/micro-switch. After the reset the alarm stays present during the alarm delay time. In the functional schematic below the basic alarm function is explained.

6.2 FUNCTIONAL ALARM SCHEMATIC

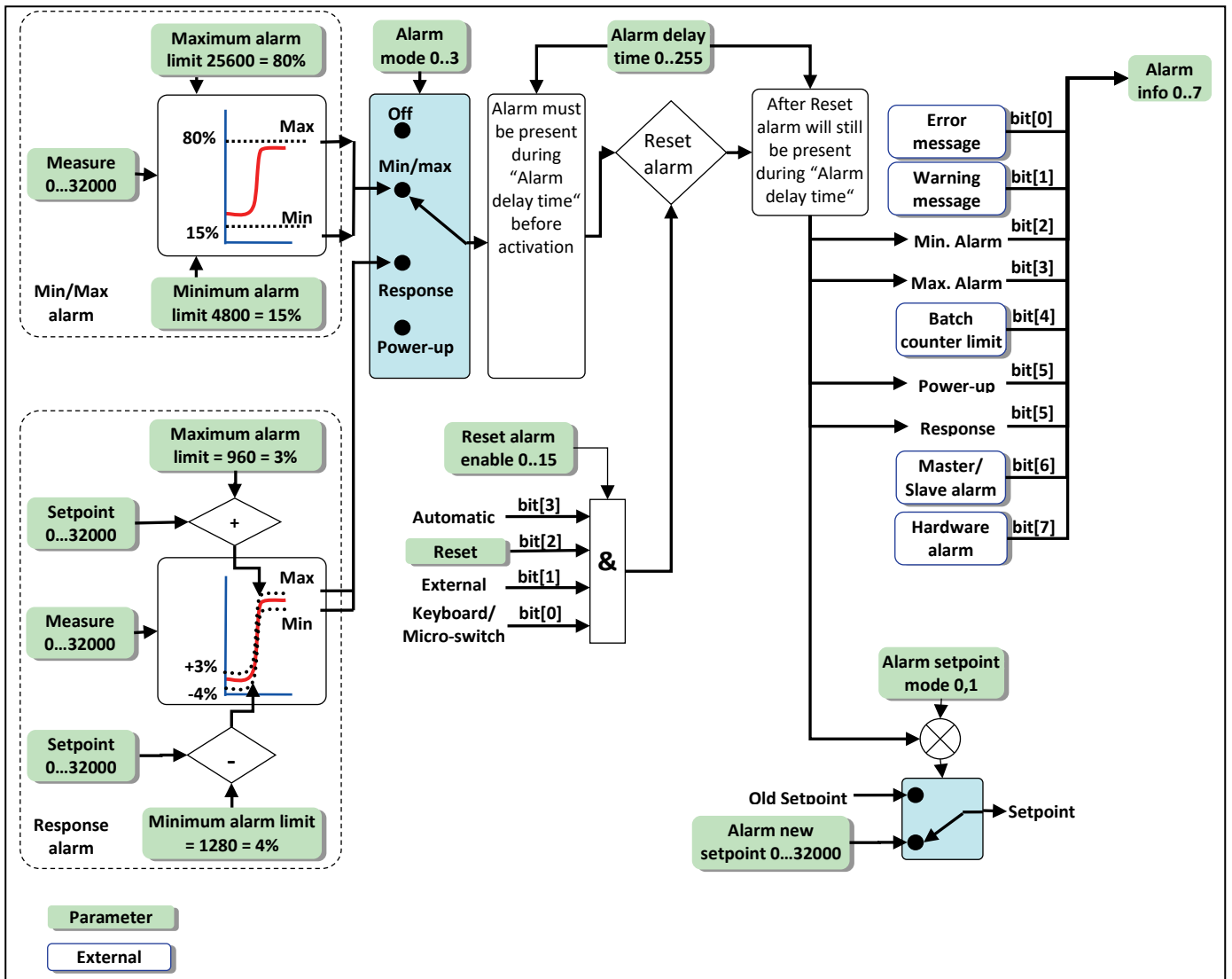

	Data Type	Range	read/write	Secured	DDE	Proc/par
6.3 ALARM INFO	unsigned char	0...255	R	N	28	1/20

This parameter contains 8 bits with status information about some (alarm) events in the instrument.

Bit	Decimal Value	low (0)	High (1)
0	1	no error	An error occurred: Alarm register 2 contains an error
1	2	no error	A warning occurred: Alarm register 1 contains a warning
2	4	no error	Minimum alarm: Sensor signal < minimum limit
3	8	no error	Maximum alarm: Sensor signal > maximum limit
4	16	no error	Batch counter: Reached its limit
5	32	no error	This bit only: Power-up alarm (probably power dip occurred) Together with bit 2 or bit 3: Response alarm message (setpoint-measure too much difference) (bit 2 or bit 3 indicate if difference is positive or negative)
6	64	no error	Master/slave alarm: master output signal not received or slave factor out of limits (> 100%)
7	128	no error	Hardware alarm: check hardware

	Data Type	Range	read/write	Secured	DDE	Proc/par
6.4 ALARM MODE	unsigned char	0...3	RW	N	118	97/3

Available alarm modes for device:

Value	Description
0	Off
1	alarm on absolute limits
2	alarm on limits related to setpoint (response alarm)
3	alarm when instrument powers-up (e.g. after power-down)



Not all modes are available for all field busses. E.g. for DeviceNet only mode 0 and 1 are available.

	Data Type	Range	read/write	Secured	DDE	Proc/par
6.5 ALARM MAXIMUM LIMIT	unsigned int	0...41600	RW	N	116	97/1

Maximum limit for sensor signal to trigger alarm situation (after delay time).



Minimum limit ≤ Maximum limit ≤ 100%

	Data Type	Range	read/write	Secured	DDE	Proc/par
6.6 ALARM MINIMUM LIMIT	unsigned int	0...41600	RW	N	117	97/2

Minimum limit for sensor signal to trigger alarm situation (after delay time).



0% ≤ Minimum limit ≤ Maximum limit

	Data Type	Range	read/write	Secured	DDE	Proc/par
6.7 ALARM SETPOINT MODE	unsigned char	0...1	RW	N	120	97/5

Available alarm setpoint modes for device:

Value	Description
0	no setpoint change at alarm
1	new/safe setpoint at alarm enabled (set at alarm new setpoint)

	Data Type	Range	read/write	Secured	DDE	Proc/par
6.8 ALARM NEW SETPOINT	unsigned int	0...32000	RW	N	121	97/6

New setpoint value (see chapter 4.4 Setpoint) when an alarm occurs at alarm mode 0, 1 or 2 (until reset).

By default this value is set to 0.

6.9 ALARM DELAY TIME	unsigned char	0...255	RW	N	182	97/7
-----------------------------	---------------	---------	----	---	-----	------

Time in seconds alarm action will be delayed when alarm limit has been exceeded.

Also time in second's automatic reset will be delayed when sensor signal reaches safe level again.

6.10 RESET ALARM ENABLE	unsigned char	0...15	RW	N	156	97/9
--------------------------------	---------------	--------	----	---	-----	------

Available alarm reset options:

	Automatic	Reset par 114	External*	Keyboard/ micro-switch
Value	bit[3]	bit[2]	bit[1]	bit[0]
0	0	0	0	0
1	0	0	0	1
2	0	0	1	0
3	0	0	1	1
4	0	1	0	0
5	0	1	0	1
6	0	1	1	0
7	0	1	1	1
8	1	0	0	0
9	1	0	0	1
10	1	0	1	0
11	1	0	1	1
12	1	1	0	0
13	1	1	0	1
14	1	1	1	0
15	1	1	1	1



*External is not used in MBC-II and MBC3 type instruments.

6.11 STATUS	unsigned char	0...255	R	N		
--------------------	---------------	---------	---	---	--	--

This parameter is a special byte for monitoring PROFIBUS DP communication. It contains 8 bits with information about certain (alarm) events.

Bit	Decimal Value	Low (0)	High (1)
0	1	no error in communication with channel	error in communication
1	2	no parameter process error	a parameter process error has occurred
2	4	no parameter error	a parameter error has occurred
3	8	no parameter type error	a parameter type error has occurred
4	16	no parameter value error	a parameter R value error has occurred
5	32	no error	a parameter process claim or command error has occurred
6	64	Reserved	
7	128	Reserved	



This parameter cannot be read via FlowDDE.

6.12 STATUS OUT POSITION	unsigned char	0...255	R	N		
---------------------------------	---------------	---------	---	---	--	--

Index pointing to the first byte in the PROFIBUS DP output data for which the above status bits applies (only for PROFIBUS DP).



This parameter cannot be read via FlowDDE.

6.13 USING AN ALARM (EXAMPLES)

Using the alarms will take three steps:

1. Preparing the instrument (setting correct values for mode, limits etc.)
2. Monitoring the alarm info byte (gives info which alarm has occurred)
3. Resetting the alarm (will re-initialize the alarm and set output to normal values again)

6.13.1 Using maximum and minimum alarm

This alarm will check if the measured signal crosses the maximum or minimum limit set by the user.

Example	Send following parameter values:		
	Action	Parameter	Value
Maximum alarm on 90%.	send to	Alarm maximum limit	28800
Minimum alarm on 10%.	send to	Alarm minimum limit	3200
No new setpoint wanted at crossing alarm limit.	send to	Alarm setpoint mode	0
		Reset alarm enable *	12
Delay on action at output should be 10 seconds.	send to	Alarm delay time	10
Reset should be automatically, when signal comes into safe area again or via FLOW-BUS.	send to	Alarm mode	1

*) Default all reset inputs are enabled, so this command isn't really necessary

Now the alarm will be active.

Alarm status can be monitored by means of parameter alarm info.

Resetting the alarm will need the following command reset = 0 and then reset = 2.

To inactivate the alarm, put it in alarm mode "off". This will also reset your outputs.

This can be done sending command: alarm mode = 0.

6.13.2 Using instrument with response alarm

This alarm will check if the measured value will come within an area limited by maximum limit and minimum limit, related to the setpoint, within a certain delay-time.

Example	Send following parameter values:		
	Action	Parameter	Value
Maximum alarm limit on setpoint + 3%.	send to	Alarm maximum limit	960
Minimum alarm limit on setpoint – 0.9%.	send to	Alarm minimum limit	288
Setpoint wanted at crossing alarm limit = 0%.	send to	Alarm setpoint mode	1
	send to	Alarm new setpoint	0
	send to	Reset alarm enable *	5
Delay on action at output should be 2 minutes.	send to	Alarm delay time	120
Reset via keyboard or BUS/RS232.	send to	Alarm mode	2

*) Default all reset inputs are enabled, so this command isn't really necessary

Now the alarm will be active.

Alarm status can be monitored by means of parameter alarm info.

Resetting the alarm will need the following command reset = 0 and then reset = 2.

To inactivate the alarm, put it in alarm mode "off". This will also reset your outputs.

This can be done sending command: alarm mode = 0.

7 COUNTER PARAMETERS

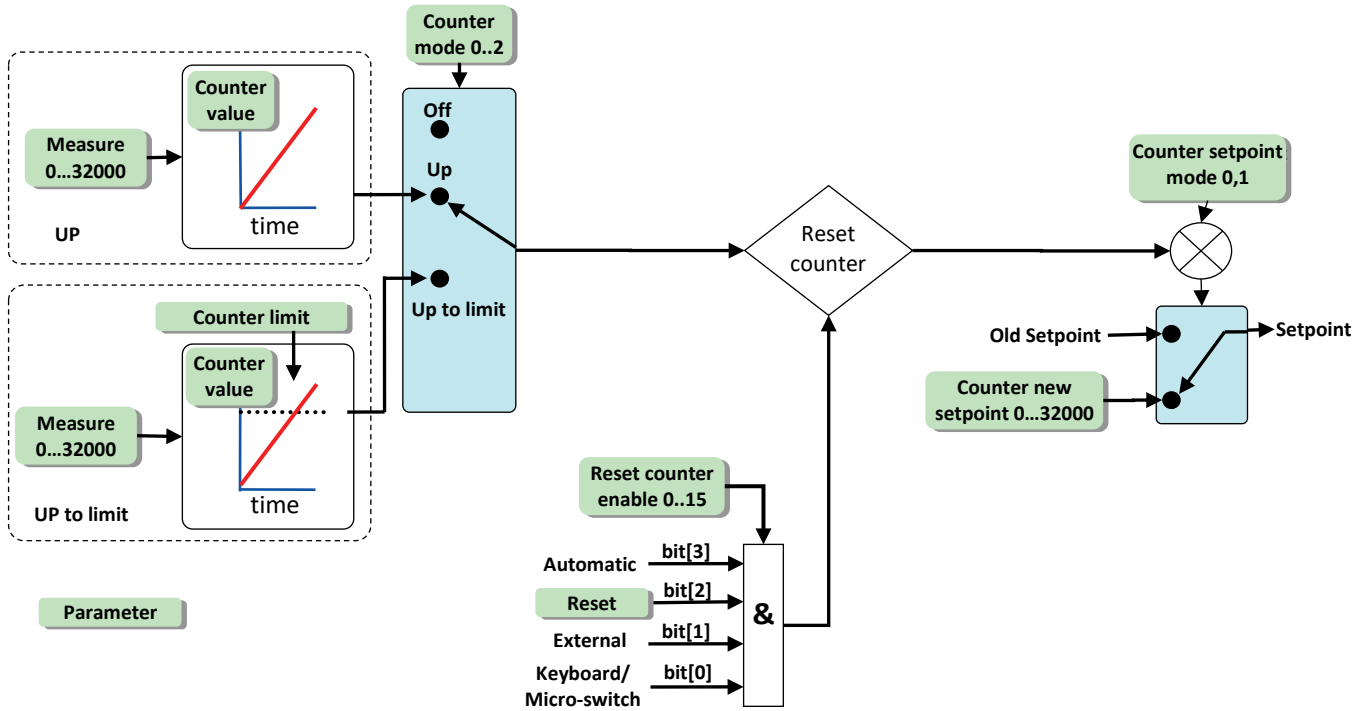

	Data Type	Range	read/write	Secured	DDE	Proc/par								
7.1 COUNTER VALUE	float	0...10000000	RW	N	122	104/1								
Actual counter value in units selected at Counter unit. Value is a float in IEEE-754 32-bits single precision notation.														
7.2 COUNTER MODE	Unsigned char	0...2	RW	N	130	104/8								
Available counter modes for device:														
<table border="1"> <thead> <tr> <th>Value</th> <th>Description</th> </tr> </thead> <tbody> <tr> <td>0</td> <td>Off</td> </tr> <tr> <td>1</td> <td>counting upwards continuously</td> </tr> <tr> <td>2</td> <td>counting up to limit (batch counter)</td> </tr> </tbody> </table>							Value	Description	0	Off	1	counting upwards continuously	2	counting up to limit (batch counter)
Value	Description													
0	Off													
1	counting upwards continuously													
2	counting up to limit (batch counter)													
Default value = 0.														
7.3 COUNTER SETPOINT MODE	Unsigned char	0...1	RW	N	126	104/5								
Setpoint change enable during counter limit/batch situation (until reset). Default = 0.														
<table border="1"> <thead> <tr> <th>Value</th> <th>Description</th> </tr> </thead> <tbody> <tr> <td>0</td> <td>no setpoint change at batch limit allowed</td> </tr> <tr> <td>1</td> <td>setpoint change at batch limit allowed</td> </tr> </tbody> </table>							Value	Description	0	no setpoint change at batch limit allowed	1	setpoint change at batch limit allowed		
Value	Description													
0	no setpoint change at batch limit allowed													
1	setpoint change at batch limit allowed													

7.4 COUNTER NEW SETPOINT	Unsigned int	0...32000	RW	N	127	104/6
New setpoint value (see chapter 4.4 Setpoint) when counter value has reached the counter limit (until reset). By default this value is set to 0.						
7.5 COUNTER LIMIT	float	0...9999999	RW	N	124	104/3
Counter limit/batch in units selected at Counter unit. Value is a float in IEEE-754 32-bits single precision notation. Default setting is 0 ln.						
7.6 COUNTER UNIT INDEX	Unsigned char	0...13	RW	N	123	104/2



This parameter gives access to the limited unit table which is available for MBC-II and MBC3 type of instruments.

Counter unit index is a pointer to select an actual readout unit (see list below).

		counter unit index table (limited unit table)													
		0	1	2	3	4	5	6	7	8	9	10	11	12	13
Sensor Type	1	l	mm3	ml	cm3	ul	m3								
	2	g	mg	ug	kg										
	3	ln	mm3n	mln	cm3n	uln	dm3n	m3n	uls	mm3s	mls	cm3s	ls	dm3s	m3s

Sensor type number explanation:

nr	Sensor type
0	pressure (no counting allowed)
1	liquid volume
2	liquid/gas mass
3	gas volume
4	other sensor type (no counting allowed)

7.7 COUNTER UNIT	unsigned char[4]	string	RW	N	128	104/7
-------------------------	------------------	--------	----	---	-----	-------



This parameter gives access to the extended counter unit table which is available for MBC3 type of instruments only.



This parameter can only be read for MBC-II type of instruments.



*For MBC3 type of instruments this parameter can be read and written.
The easiest way to change a unit in the MBC3 type of instrument is to fill in the unit needed from the table below.*

The “Counter unit” displays the unit name set by “Counter unit index”. A valid “Counter unit”(for example ln) can also be entered here which changes the “Counter unit index”.

In MBC3 type of instruments the parameter is not secured.

Extended counter unit table							
Mass	ug	mg	g	kg			
Custom volume	ul	ml	l	mm3	cm3	dm3	m3
Normal volume	uln	mln	ln	mm3n	cm3n	dm3n	m3n
Standard volume	uls	mls	ls	mm3s	cm3s	dm3s	m3s



7.8 RESET COUNTER ENABLE	Unsigned char	0...15	RW	N	157	104/9
---------------------------------	---------------	--------	----	---	-----	-------

Available counter reset options:

	Automatic	Reset par 114	External*	Keyboard/micro-switch
Value	bit[3]	bit[2]	bit[1]	bit[0]
0	0	0	0	0
1	0	0	0	1
2	0	0	1	0
3	0	0	1	1
4	0	1	0	0
5	0	1	0	1
6	0	1	1	0
7	0	1	1	1
8	1	0	0	0
9	1	0	0	1
10	1	0	1	0
11	1	0	1	1
12	1	1	0	0
13	1	1	0	1
14	1	1	1	0
15	1	1	1	1



**External is not used in MBC-II and MBC3 type instruments.*

7.9 COUNTER CONTROLLER OVERRUN CORRECTION	float	0...3.40282E+38	RW	N	274	104/10
	<i>CORI-FLOW instruments only.</i>					
7.10 COUNTER CONTROLLER GAIN	float	0...3.40282E+38	RW	N	275	104/11
	<i>CORI-FLOW instruments only.</i>					

7.11 USING A COUNTER (EXAMPLE)

Using the counter will take three steps:

1. Preparing the instrument (setting correct values for mode, limit etc.)
2. Monitoring the alarm info byte (gives info which alarm has occurred)
3. Resetting the counter (will re-initialize the counter and set output to normal values again)

7.11.1 Using a batch counter

The measured signal will be integrated in time and there will be a check on a certain limit set by the user.

Example	Send following parameter values:		
	Action	Parameter	Value
The batch is reached at 1000 ln.	send to	Counter limit	1000.0
New setpoint when reaching the limit to 0% (valve should be closed).	send to	Counter setpoint mode	1
	send to	Counter new setpoint	0
Reset should be enabled via BUS/RS232 or by means of keyboard/micro-switch.	send to	Reset counter enable *	5
Set counter to batch counter.	send to	Counter mode	2

**) Default all reset inputs are enabled, so this command isn't really necessary*

Now the counter will be active.





Alarm / Counter status can be monitored by means of parameter alarm info.

Resetting the counter will need the following command reset = 0 and then reset = 3.

To inactivate the counter, put it in counter mode "off". This will also reset your outputs.

This can be done sending command: counter mode = 0.

8 IDENTIFICATION PARAMETERS

	Data Type	Range	read/write	Secured	DDE	Proc/par
8.1 SERIAL NUMBER	unsigned char[20]	String	RW	 Y	92	113/3
This parameter consists of a maximum 20-byte string with instrument serial number for identification. Example: "M11202123A"						
8.2 BHTMODEL NUMBER	unsigned char[]*	String	RW	 Y	91	113/2
Bronkhorst® instrument model number information string. *For MBC-II type length = 23 bytes, for MBC3 type the length = 27 bytes						
8.3 FIRMWARE VERSION	unsigned char[6]	String	R	 Y	105	113/5
Revision number of firmware. E.g. "V1.10b"						
8.4 USERTAG	unsigned char[16]	String	RW	 Y	115	113/6
User definable alias string. Maximum 16 characters allow the user to give the instrument his own tag name.						
8.5 CUSTOMER MODEL	unsigned char[16]	String	RW	 Y	93	113/4
Digital instrument customer model information string. This string can be used by Bronkhorst® to add extra information to the model number information.						

8.6 IDENTIFICATION NUMBER	unsigned char	0...255	RW	Y	175	113/12																																																																																																																														
Bronkhorst® (digital) device/instrument identification number (pointer). See list below:																																																																																																																																				
<table border="1"> <thead> <tr> <th data-bbox="376 304 491 338">Value</th> <th data-bbox="491 304 651 338">Type</th> <th data-bbox="651 304 1353 338">Description</th> </tr> </thead> <tbody> <tr><td>0</td><td>UFO?</td><td>Unidentified FLOW-BUS Object</td></tr> <tr><td>1</td><td>RS232</td><td>RS232/FLOW-BUS interface</td></tr> <tr><td>2</td><td>PC/ISA</td><td>PC(ISA) interface</td></tr> <tr><td>3</td><td>ADDA4</td><td>ADDA4 (4 channels)</td></tr> <tr><td>4</td><td>R/C</td><td>R/C-module, 32 channels</td></tr> <tr><td>5</td><td>T/A</td><td>T/A-module</td></tr> <tr><td>6</td><td>ADDA1</td><td>1 channel ADDA converter module</td></tr> <tr><td>7</td><td>DMFC</td><td>Digital Mass Flow Controller</td></tr> <tr><td>8</td><td>DMFM</td><td>Digital Mass Flow Meter</td></tr> <tr><td>9</td><td>DEPC</td><td>Digital Electronic Pressure Controller</td></tr> <tr><td>10</td><td>DEPM</td><td>Digital Electronic Pressure Meter</td></tr> <tr><td>11</td><td>ACT</td><td>Single Actuator</td></tr> <tr><td>12</td><td>DLFC</td><td>Digital Liquid Flow Controller</td></tr> <tr><td>13</td><td>DLFM</td><td>Digital Liquid Flow Meter</td></tr> <tr><td>14</td><td>DSCM-A</td><td>Digital Single Channel Module for Analog instruments</td></tr> <tr><td>15</td><td>DSCM-D</td><td>Digital Single Channel Module for Digital instruments</td></tr> <tr><td>16</td><td>FRM</td><td>FLOW-BUS Rotor Meter (calibration-instrument)</td></tr> <tr><td>17</td><td>FTM</td><td>FLOW-BUS Turbine Meter (calibration-instrument)</td></tr> <tr><td>18</td><td>FPP</td><td>FLOW-BUS Piston Prover/tube (calibration-instrument)</td></tr> <tr><td>19</td><td>F/A</td><td>special version of T/A-module</td></tr> <tr><td>20</td><td>DSCM-E</td><td>Digital Single Channel Module for Evaporator</td></tr> <tr><td>21</td><td>DSCM-C</td><td>Digital Single Channel Module for Calibrators</td></tr> <tr><td>22</td><td>DDCM-A</td><td>Digital Dual Channel Module for Analog instruments</td></tr> <tr><td>23</td><td>DMCM-D</td><td>Digital Multi Channel Module for Digital instruments</td></tr> <tr><td>24</td><td>PRODPS</td><td>PROFIBUS DP / FLOW-BUS -slave interface</td></tr> <tr><td>25</td><td>FCM</td><td>FLOW-BUS Coriolis meter</td></tr> <tr><td>26</td><td>FBI</td><td>FLOW-BUS Balance Interface</td></tr> <tr><td>27</td><td>CORIFC</td><td>(mini) CORI-FLOW Controller</td></tr> <tr><td>28</td><td>CORIFM</td><td>(mini) CORI-FLOW Meter</td></tr> <tr><td>29</td><td>FICC</td><td>FLOW-BUS Interface Climate Control</td></tr> <tr><td>30</td><td>IFI</td><td>Instrument FLOW-BUS interface</td></tr> <tr><td>31</td><td>KFI</td><td>Keithley FLOW-BUS Interface</td></tr> <tr><td>32</td><td>FSI</td><td>FLOW-BUS Switch Interface</td></tr> <tr><td>33</td><td>MSCI</td><td>Multi Sensor/Controller Interface</td></tr> <tr><td>34</td><td>APP-D</td><td>Active Piston Prover (calibration-instrument)</td></tr> <tr><td>35</td><td>LFI</td><td>Leak tester FLOW-BUS Interface</td></tr> <tr><td>36</td><td>DBFC</td><td>Digital batch flow controller</td></tr> <tr><td>37</td><td>DPIDC</td><td>Digital PID controller</td></tr> <tr><td>38</td><td>BGW</td><td>Bus gateway</td></tr> <tr><td>39</td><td>DTC</td><td>Temperature controller</td></tr> <tr><td>40</td><td>DTM</td><td>Temperature meter</td></tr> </tbody> </table>							Value	Type	Description	0	UFO?	Unidentified FLOW-BUS Object	1	RS232	RS232/FLOW-BUS interface	2	PC/ISA	PC(ISA) interface	3	ADDA4	ADDA4 (4 channels)	4	R/C	R/C-module, 32 channels	5	T/A	T/A-module	6	ADDA1	1 channel ADDA converter module	7	DMFC	Digital Mass Flow Controller	8	DMFM	Digital Mass Flow Meter	9	DEPC	Digital Electronic Pressure Controller	10	DEPM	Digital Electronic Pressure Meter	11	ACT	Single Actuator	12	DLFC	Digital Liquid Flow Controller	13	DLFM	Digital Liquid Flow Meter	14	DSCM-A	Digital Single Channel Module for Analog instruments	15	DSCM-D	Digital Single Channel Module for Digital instruments	16	FRM	FLOW-BUS Rotor Meter (calibration-instrument)	17	FTM	FLOW-BUS Turbine Meter (calibration-instrument)	18	FPP	FLOW-BUS Piston Prover/tube (calibration-instrument)	19	F/A	special version of T/A-module	20	DSCM-E	Digital Single Channel Module for Evaporator	21	DSCM-C	Digital Single Channel Module for Calibrators	22	DDCM-A	Digital Dual Channel Module for Analog instruments	23	DMCM-D	Digital Multi Channel Module for Digital instruments	24	PRODPS	PROFIBUS DP / FLOW-BUS -slave interface	25	FCM	FLOW-BUS Coriolis meter	26	FBI	FLOW-BUS Balance Interface	27	CORIFC	(mini) CORI-FLOW Controller	28	CORIFM	(mini) CORI-FLOW Meter	29	FICC	FLOW-BUS Interface Climate Control	30	IFI	Instrument FLOW-BUS interface	31	KFI	Keithley FLOW-BUS Interface	32	FSI	FLOW-BUS Switch Interface	33	MSCI	Multi Sensor/Controller Interface	34	APP-D	Active Piston Prover (calibration-instrument)	35	LFI	Leak tester FLOW-BUS Interface	36	DBFC	Digital batch flow controller	37	DPIDC	Digital PID controller	38	BGW	Bus gateway	39	DTC	Temperature controller	40	DTM	Temperature meter
Value	Type	Description																																																																																																																																		
0	UFO?	Unidentified FLOW-BUS Object																																																																																																																																		
1	RS232	RS232/FLOW-BUS interface																																																																																																																																		
2	PC/ISA	PC(ISA) interface																																																																																																																																		
3	ADDA4	ADDA4 (4 channels)																																																																																																																																		
4	R/C	R/C-module, 32 channels																																																																																																																																		
5	T/A	T/A-module																																																																																																																																		
6	ADDA1	1 channel ADDA converter module																																																																																																																																		
7	DMFC	Digital Mass Flow Controller																																																																																																																																		
8	DMFM	Digital Mass Flow Meter																																																																																																																																		
9	DEPC	Digital Electronic Pressure Controller																																																																																																																																		
10	DEPM	Digital Electronic Pressure Meter																																																																																																																																		
11	ACT	Single Actuator																																																																																																																																		
12	DLFC	Digital Liquid Flow Controller																																																																																																																																		
13	DLFM	Digital Liquid Flow Meter																																																																																																																																		
14	DSCM-A	Digital Single Channel Module for Analog instruments																																																																																																																																		
15	DSCM-D	Digital Single Channel Module for Digital instruments																																																																																																																																		
16	FRM	FLOW-BUS Rotor Meter (calibration-instrument)																																																																																																																																		
17	FTM	FLOW-BUS Turbine Meter (calibration-instrument)																																																																																																																																		
18	FPP	FLOW-BUS Piston Prover/tube (calibration-instrument)																																																																																																																																		
19	F/A	special version of T/A-module																																																																																																																																		
20	DSCM-E	Digital Single Channel Module for Evaporator																																																																																																																																		
21	DSCM-C	Digital Single Channel Module for Calibrators																																																																																																																																		
22	DDCM-A	Digital Dual Channel Module for Analog instruments																																																																																																																																		
23	DMCM-D	Digital Multi Channel Module for Digital instruments																																																																																																																																		
24	PRODPS	PROFIBUS DP / FLOW-BUS -slave interface																																																																																																																																		
25	FCM	FLOW-BUS Coriolis meter																																																																																																																																		
26	FBI	FLOW-BUS Balance Interface																																																																																																																																		
27	CORIFC	(mini) CORI-FLOW Controller																																																																																																																																		
28	CORIFM	(mini) CORI-FLOW Meter																																																																																																																																		
29	FICC	FLOW-BUS Interface Climate Control																																																																																																																																		
30	IFI	Instrument FLOW-BUS interface																																																																																																																																		
31	KFI	Keithley FLOW-BUS Interface																																																																																																																																		
32	FSI	FLOW-BUS Switch Interface																																																																																																																																		
33	MSCI	Multi Sensor/Controller Interface																																																																																																																																		
34	APP-D	Active Piston Prover (calibration-instrument)																																																																																																																																		
35	LFI	Leak tester FLOW-BUS Interface																																																																																																																																		
36	DBFC	Digital batch flow controller																																																																																																																																		
37	DPIDC	Digital PID controller																																																																																																																																		
38	BGW	Bus gateway																																																																																																																																		
39	DTC	Temperature controller																																																																																																																																		
40	DTM	Temperature meter																																																																																																																																		
8.7 DEVICE TYPE	unsigned char[6]	String	R	N	90	113/1																																																																																																																														
Device type information string: String value in max. 6 characters of descriptions in table above.																																																																																																																																				

9 SPECIAL PARAMETERS

	Data Type	Range	read/write	Secured	DDE	Proc/par
9.1 RESET	Unsigned char	0...7	W	N	114	115/8

Parameter to reset program, counter or alarms. Default value = 0.

Value	Description
0	no reset
1	reset counter value (no mode change) or common reset
2	reset alarm
3	restart batch counter
4	reset counter value (counter off)
5	reset module (soft reset)
6	reset alarm info error bit (bit 0) See 'Alarm info'
7	reset alarm info warning bit (bit 1) See 'Alarm info'



To make sure the parameter is accepted send a 0 first.

9.2 INITRESET	Unsigned char	0...255	RW	N	7	0/10
----------------------	---------------	---------	----	---	---	------

 key parameter)

Init and reset security key command for network/parameter settings.

Write 64 to enable changing of secured parameters. Write 82 or 0 to disable changing of secured parameters.



When an instrument powers-up this value will be reset to 82 automatically.

9.3 WINK	Unsigned char	0...9	W	N	1	0/0
-----------------	---------------	-------	---	---	---	-----

Unsigned char in range '0'...'9' send to this parameter lets the instrument which is addressed wink for several seconds for tracing the physical location. Type of winking depends on instrument. This will be either with red and green LED turn-by-turn or with special characters on a display. Default setting = 0.

9.4 IOSTATUS	Unsigned char	0...255	RW	 Y	86	114/11
---------------------	---------------	---------	----	---	----	--------

The parameter IOStatus (parameter 86) is used to read and enable / disable the physical jumpers and micro switch.

Bit	Decimal Value	Explanation	Read/Write	Default
0	1	true = read 'special purpose' jumper	RW	1
1	2	not used		1
2	4	true = read 'analog mode jumper'	RW	1
3	8	true = read 'micro switch'	RW	1
4	16	special purpose jumper off/on	R(W)	(0)
5	32	internal initialization jumper off/on	R(W)	(0)
6	64	analog mode jumper off/on	R(W)	(0)
7	128	micro switch off/on	R	



For bits 4,5,6 the jumper can be a real jumper on the pc board or a virtual jumper (MBC3 type).
In case of a real jumper the bits 4,5,6 are read from the pc board.
In case of a virtual jumper the bits 4,5,6 are set by firmware (MBC3 type).

9.4.1 Examples of using parameter IOstatus

- When the analog jumper is set the value of parameter 86 will read: $1+2+4+8+64 = 79$
- To disable the micro switch bit 3 must be false, value of parameter 86 must be set to.: $1+2+4 = 7$
- To disable the analog jumper bit 2 must be false, value of parameter 86 must be set to: $1+2+8 = 11$

Bit 2 = 0 (don't read 'analog jumper')

At power-on of an instrument the jumper will not be read.

The control mode will remain on the value as it was before power-off.

Only when the control mode before power-off is set to the value 5, 9, 18 or 19 the control mode will switch to 0 (digital).

Bit 2 = 1 (read 'analog jumper')

At power-on of an instrument the jumper will be read.

Only when the control mode before power-off is set to the value 0, 1, 5, 9, 18 or 19 the control mode will switch to:

- 0 (digital) when jumper 2 is not placed.
- 1 (analog input) when jumper 2 is placed.

9.4.2 Examples of using real jumpers (MBC-I and MBC-II type)

In normal operation it is not necessary to change the jumper setting. If it cannot be avoided, the jumpers can be reached by removing the uppercase of the housing. Opening the uppercase should be done with great care, because the connection of the field bus and main p.c. board is accomplished by a small flat conductor cable.

Each jumper or switch can be used to make a certain setting by placing a link between a set of pins or by switching one of the DIP-switches as shown below:

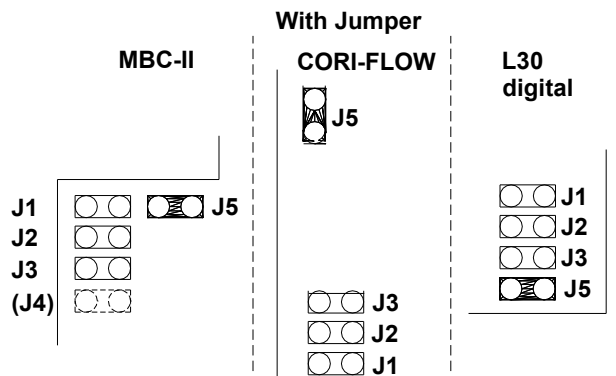
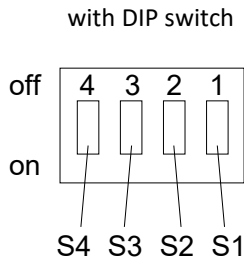
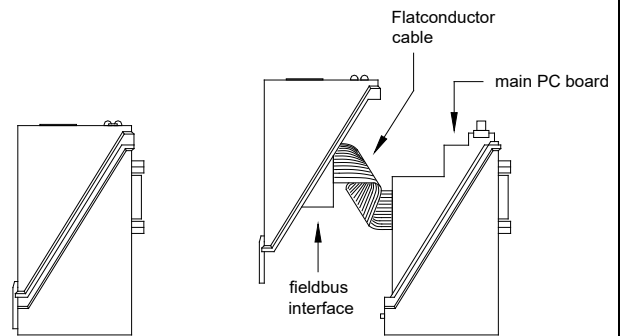

Switch	Jumper	IOstatus bit	When placed (on)	When not placed (off)	Remarks
S2	J1	5	Default settings from EPROM loaded at power-up	Settings loaded from non-volatile memory at power-up	If S2 is placed all settings are erased, including factory calibration.
S3	J2	6	Analog input used as standard setpoint for controller at power-up	Digital (bus) input used as standard setpoint for controller at power-up	Setting depends on how instrument was ordered. Setting can be changed during normal operation using parameter "Control Mode". At next power-up however, controller will read jumper first for setpoint source.
S4	J3	4	reserved		
-	J4		reserved		Not always present
S1	J5		Normal RS232 communication	Instrument in FLASH mode	

9.4.3 Example of using the virtual 'analog mode jumper' (MBC3 type)

MBC3 instruments can be recognised by the "MBC3" placed on lower left side of the instrument label (see example in the chapter "MULTIBUS TYPES").

At power-up of an instrument the 'virtual' 'analog mode jumper' (Bit 6 of parameter 86) will determine whether an instrument will be set to "Analog input"(Analog) or "BUS/RS232"(Digital) Control mode.

The typical value's for the parameter 86 (IO Status) are:

Value: 79 - Control mode: Analog input (Analog)

Value: 15 - Control mode: BUS/RS-232 (Digital)

Example:

Example using the FLOWDDE server software to change the Control mode from "Analog input" to "BUS/RS-232" .

Start the FLOWDDE Server software, open the communication and write and read the parameters as advised below.

- FlowDDE Server software: menu "Flow-BUS" → "test Flow-BUS and DDE"

At 'Test FLOW-BUS' select your Channel and Parameter(see below):

- Parameter 7: (initreset) → Write value 64 (actual value is 82)

- Parameter 7 (initreset)→ Read parameter and check value

- Parameter 86: (IO status) → Write value 15 (actual value is 79)

- Parameter 86: (IO status) → Read parameter and check value

- Parameter 7: (initreset) → Write value 82 (actual value is 64)

- Parameter 7 (initreset) → Read parameter and check value

Now the bit 6 of parameter 86 is set to zero and at power-up the control mode will be set to 'RS232/BUS' .



For some FLOWDDE Server versions you have to uncheck 'Hide advance parameters' in the menu 'Server' → 'Settings' of Flow-DDE to obtain access to the DDE Parameter 86 (IO Status).



-If the actual control mode is not equal to 0, 1, 9 or 18, it will not be overruled by the 'virtual' 'analog mode jumper' .

10 SPECIAL INSTRUMENT FEATURES

10.1 ZEROING

Not applicable for: EL-PRESS (Metal Sealed) Series
IN-PRESS Series
LIQUI-FLOW Series L10(I) / L20(I)
LIQUI-FLOW Series L30

The zero procedure is able to remove zero offset signals on the sensor signal automatically. This automatic procedure can be started through the BUS/RS232 or by means of the switch on the instrument.

10.1.1 Zeroing with the micro-switch

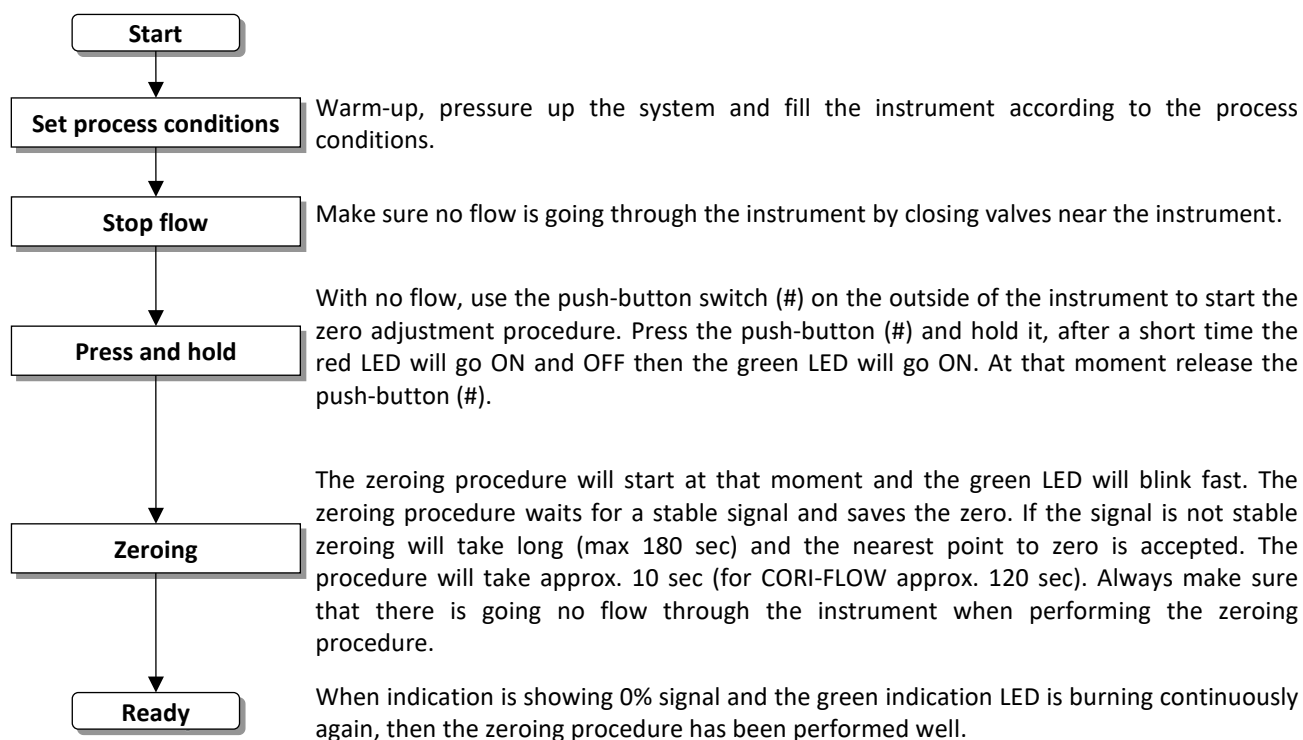

10.1.2 Zeroing with digital communication

The following parameters must be used for zeroing an instrument:

Initreset	[unsigned char, RW,0...255, DDEpar. = 7, Process/par. = 0/10]
Control mode	[unsigned char, RW,0...255, DDEpar. = 12, Process/par. = 1/4]
Calibration mode	[unsigned char, RW,0...255, DDEpar. = 58, Process/par. = 115/1]

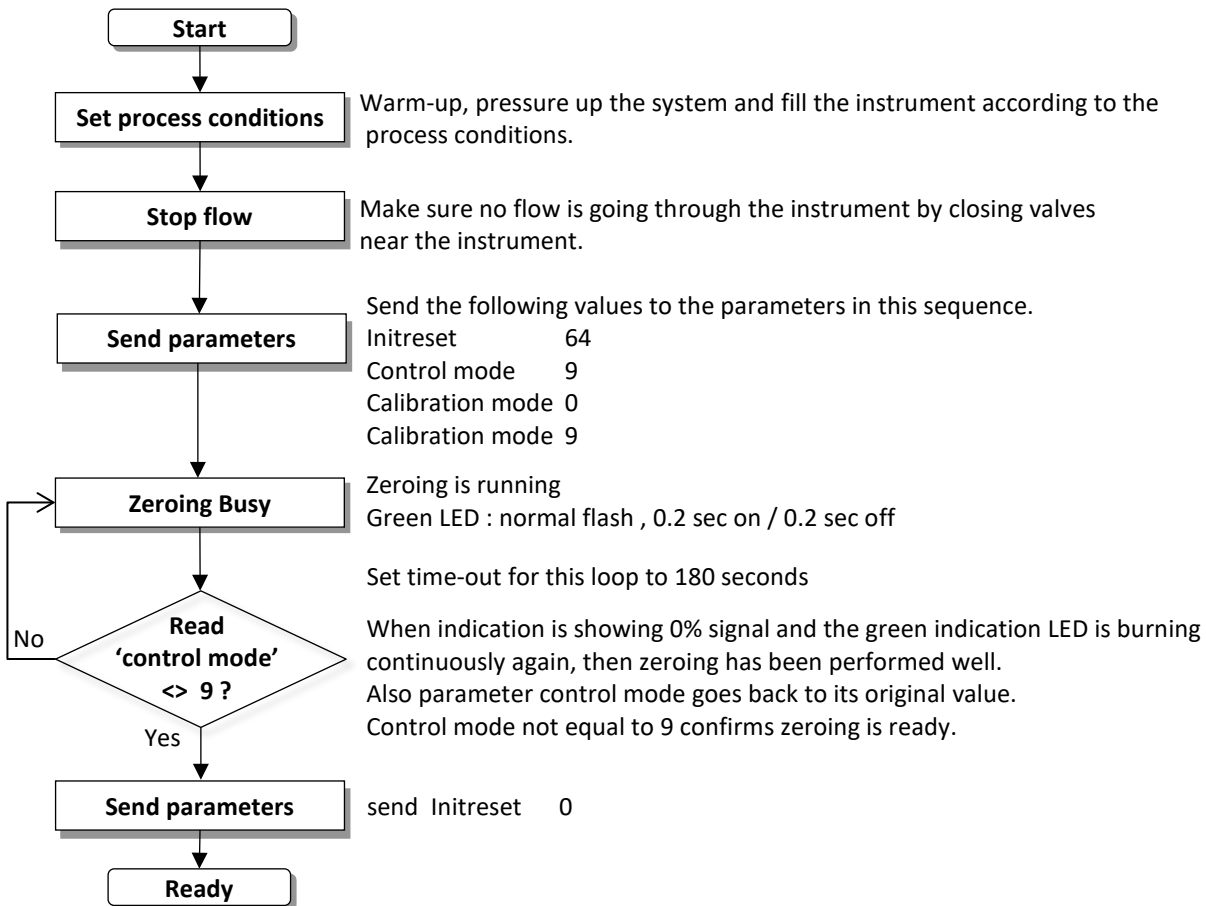

This action will be performed already during production at Bronkhorst®, but may be repeated at wish on site



For (mini) CORI-FLOW always perform a zero on site.

10.2 RESTORE PARAMETER SETTINGS

All parameter value settings in the instruments are stored in non-volatile memory so each time at power-up these settings are known. However, several settings can be changed afterwards in the field by a user if needed. Sometimes it may be necessary to get back all original settings. Therefore a backup of all settings, at production final-test, are stored in non-volatile memory. Because of this it is possible to restore these original factory settings at any moment. Restoring original factory settings can be achieved by means of the micro-switch on top of the instrument or through a command via BUS/RS232. See instructions for manual operation with switch and LED's for details.

10.3 BUS CONFIGURATION MODE

When the serial communication at the instrument connector (the '9 pin D-Sub connector' or '8DIN connector') is not configured as RS-232 the instrument cannot be accessed by using the Bronkhorst® FlowDDE Software. The FlowDDE software requires the FLOW-BUS protocol over RS232 at a baudrate of 38400 baud.

In the 'Bus Configuration Mode' the serial communication at the instrument connector is forced to the FLOW-BUS protocol over RS232 at a baudrate of 38400 baud.

To activate the Configuration Mode by means of the micro switch push button:

1. The power supply of the instrument is switched off.
2. Push the button and hold it while switching on the power
3. Release the button when both LED's are blinking.

The Configuration Mode is active, communication by FlowDDE is possible.

If the configuration mode is active then the green LED will show a pattern: 2s ON and 0.1s OFF

(Please also see the Led indications table of instruments in normal running mode).



This mode is a toggle mode and it will remain after the instrument is powered off and on again.



The bus safe state will not function if the bus configuration mode is activated.

11 MANUAL INTERFACE: MICRO-SWITCH AND LED'S

11.1 GENERAL

The micro-switch on top of the digital instrument can be used to start a certain function at the instrument. When the switch is pressed down, both LED's will start indicating different patterns in a loop. The switch has to be pressed down until the 2 LED's are indicating the right pattern. Then the switch has to be released and the choice has been made.

Normally (when the switch is not pressed) the green and red LED are used for mode indication on digital instruments.

11.1.1 LED and switch locations

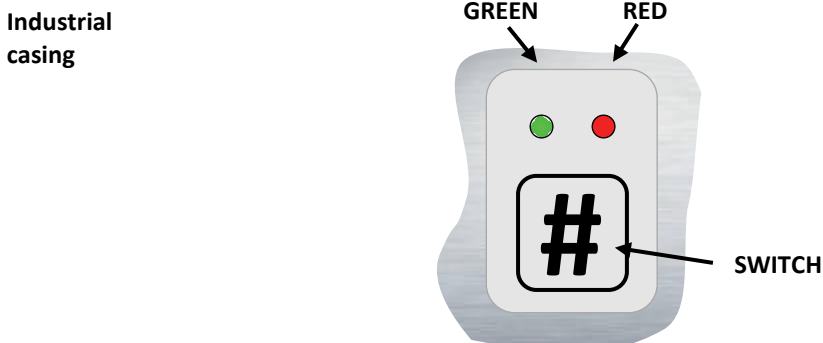
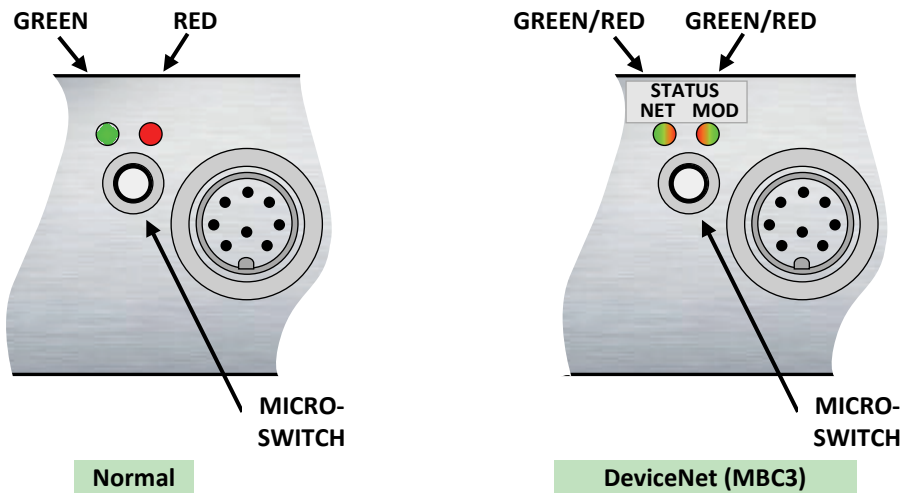
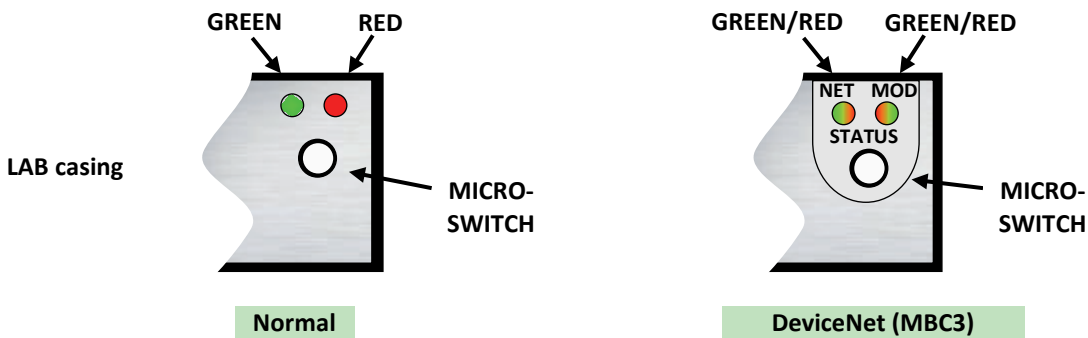

11.2 LED'S INDICATIONS

11.2.1 LED indications mode (no switch used)

Led	Time	Indication	
● Green			
off	Continuous	Power-off or program not running	
on	Continuous	Normal running/operation mode	
Short flash	0.1 sec on 2.0 sec off	Initialization mode (Init reset = 73) For MBC3 type: no bus communication, safe state active.	
normal flash	0.2 sec on 0.2 sec off	Special function mode Instrument is busy performing any special function. E.g. auto-zero or self-test	
long flash	2.0 sec on 0.1 sec off	For MBC3 type: Bus configuration mode enabled.	
		FLOW-BUS	Not used
		PROFIBUS DP	Not used
		Modbus	Not used
		DeviceNet (MBC-II)	Idle state
		DeviceNet (MBC3)	See special table below
		EtherCAT	Not used
		PROFINET	Not used
● Red			
off	Continuous	No error	
Short flash	0.1 sec on 2.0 sec off	Special mode, see specific field bus for more details	
		FLOW-BUS	Node occupied: Re-install instrument
		PROFIBUS DP	No data-exchange between master and slave Automatic recovery
		Modbus	Data is received or transmitted
		DeviceNet (MBC-II)	Minor communication error
		DeviceNet (MBC3)	See special table below
		EtherCAT	Instrument is not in OP mode (see EtherCAT manual for details)
		PROFINET	No application relation established
normal flash	0.2 sec on 0.2 sec off	Warning message. An error occurred of minor importance. It would be wise to investigate the cause of this. You are still able to work with your instrument. See specific field bus for more details	
		FLOW-BUS	Waiting for communication
		PROFIBUS DP	No details
		Modbus	No details
		DeviceNet (MBC-II)	No bus power
		DeviceNet (MBC3)	See special table below
		EtherCAT	Not used
		PROFINET	Not used
long flash	2.0 sec on 0.1 sec off	See specific field bus for more details	
		FLOW-BUS	Not used
		PROFIBUS DP	A requested parameter is not available. See troubleshoot in PROFIBUS DP manual.
		Modbus	For special service purpose only
		DeviceNet (MBC-II)	Serious communication error; manual intervention needed
		DeviceNet (MBC3)	See special table below
		EtherCAT	Error detected in EtherCAT configuration (see EtherCAT manual for details)
		PROFINET	Configuration error. E.g. a requested parameter is not available.
on	Continuous	Critical error message. A serious error occurred in the instrument. Instrument needs service before further using.	

Wink Mode ● Green ● Red ● Green ● Red turn by turn		
slow wink	0.2 sec on 0.2 sec off	Wink mode By a command send via FLOW-BUS the instrument can “wink” with Led’s to indicate its position in a (large) system
normal wink	1.0 sec on 1.0 sec off	Alarm indication: minimum alarm, limit/maximum alarm; power-up alarm or limit exceeded or batch reached.
fast wink	0.1 sec on 0.1 sec off	Switch-released, selected action started

11.2.2 LED indications mode (DeviceNet MBC3)

for this state	Led	Indication
Network status LED (NET)		
Not powered/ Not online	Off	Device is not online <ul style="list-style-type: none"> The device has not been completed the Dup_MAC_ID test yet. The device may not be powered, look at module status LED No network power present
Link OK, Online, Connected	On ● green	Device is online and has connections in the established state <ul style="list-style-type: none"> For a group 2 device it means that the device is allocated to a master.
Online, Not connected	Flashing ● green 0.5 sec on 0.5 sec off	The device is online but has no connections in the established state. <ul style="list-style-type: none"> The device has passed the Dup_MAC_ID test, is online but has no established connections to other nodes For a group 2 device it means that the device is not allocated to a master.
Connection Time-out	Flashing ● red 0.5 sec on 0.5 sec off	One or more I/O connections are in timed-out state.
Critical link Failure	On ● red	Failed communication device. The device has detected an error that has rendered it incapable of communicating on the network. (Duplicate MAC ID or bus off)
Module status LED (MOD)		
No power	Off	There is no power applied to the device
Device operational	On ● green	The device is operating in normal condition.
Device in Standby (The device needs commissioning)	Flashing ● green 0.5 sec on 0.5 sec off	The device needs commissioning due to configuration missing, incomplete or incorrect. The device may be in the standby state.
Unrecoverable fault	On ● red	The device has an unrecoverable fault, may need replacing.
Device self-testing	Flashing red / green 0.5 sec on 0.5 sec off	The device is in self-test.
Module and status LEDs sequence at power-up		
Network LED (NET)	off	
Module LED (MOD)	● green	0.25 sec
Module LED (MOD)	● red	0.25 sec
Module LED (MOD)	● green	
Network LED (NET)	● green	0.25 sec
Network LED (NET)	● red	0.25 sec
Network LED (NET)	off	

11.2.3 LED indications using micro-switch at normal running mode of an instrument

When the switch is pressed-down both LED's will be switched-off for function selection. As long as the switch will be pressed-down, there will be a change in indication by the 2 LED's after each 4 seconds. The moment the user recognizes the indication (LED-pattern) for the function he wants, he must release the switch. Now the wanted function is triggered.

LED		Time	Indication
● Green	● Red		
off	off	0...1 sec	Pressing a switch shortly by accident will not cause unwanted reactions of instrument.
off	off	1...4 sec	In case of min/max alarm or counter batch reached: Reset alarm (only if reset by keyboard has been enabled) See specific field bus for more details.
			FLOW-BUS When address is occupied: Automatic installation on FLOW-BUS.
			PROFIBUS DP Not used
			Modbus Not used
			DeviceNet (MBC-II) Not used
			DeviceNet (MBC3) Not used
			EtherCAT Not used
			PROFINET Not used
off	on	4...8 sec	Reset instrument Instrument program will be restarted and all warning and error message will be cleared. During a start-up the instrument will perform a self-test
on	off	8...12 sec	Auto-zero Instrument will be re-adjusted for measurement of zero-flow (not for pressure meter/controller) NOTE: First make sure there is no flow and instrument is connected to power for at least 30 minutes!
on	on	12...16 sec	Set instrument in the FLASH mode This mode will be indicated by both LED's off when instrument is normally powered

11.2.4 LED indications using micro-switch at power-up situation

Here is described what the indications are for the functions to be performed at power-up situation of an instrument. This can be realized by pressing the switch first and while pressing, connecting the power. These actions have a more 'initializing' character for the instrument.

LED		Time	Indication
● Green	● Red		
off	off	0...4 sec	No action Pressing a switch shortly by accident will not cause unwanted reactions of the instrument.
off	normal flash 0.2 sec on, 0.2 sec off	4...8 sec	Restore parameters All parameter settings (except field bus settings) will be restored to situation of final test at BHT production.
normal flash 0.2 sec on, 0.2 sec off	off	8...12 sec	See specific field bus for more details.
			FLOW-BUS Auto install to bus Instrument will install itself to a (new) free node-address on the FLOW-BUS.
			PROFIBUS DP / Modbus Not used
			Modbus Not used
			DeviceNet (MBC-II) Not used
			DeviceNet (MBC3) Not used
			EtherCAT Not used
			PROFINET Not used

normal flash 0.2 sec on, 0.2 sec off	normal flash 0.2 sec on, 0.2 sec off	12...16 sec	For MBC-II type of instruments, the default address will be set immediately. The default address will be set after leaving this mode (approx. 60 sec) See specific field bus for default installation address:
			FLOW-BUS Node-address = 0
			PROFIBUS DP Station address = 126
			DeviceNet (MBC-II) MAC-ID = 63
For MBC3 type of instruments the "configuration mode" is activated*			



*MBC3 type instruments have additional functionality for Remote/manual install. It also sets the baud rate and bus type for the main connector back to its default value as is 38K4 and type RS232. This is called the "configuration mode"
The bus safe state will not function if the bus configuration mode is activated.

11.3 MICRO-SWITCH USE FOR READING / SETTING ADDRESS / MAC-ID AND BAUDRATE

11.3.1 General

The micro-switch can be used for several functions. The function it triggers may be depending on the present field bus. Use the micro-switch always in combination with the LED's to prevent errors. The following functions can be triggered with the micro-switch.

- Set instrument to default installation address/MAC-ID
- Read bus-address/MAC-ID and baud rate
- Change bus-address/MAC-ID and baud rate
- Read control mode
- Change control mode

To read or change settings by the micro-switch and LED's, the number can be separated in "tens" and "units". The "tens" is the most left part of the number. The "unit" is the most right decimal of the number.

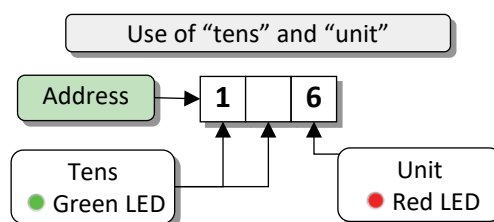

The easiest way to set an address / baud rate is by using the rotary switches on the instrument (if present). Remember that the rotary switch setting overrides software setting at start-up if the switches are not in the soft-address position.

11.3.2 Readout bus-address/MAC-ID and baudrate:

Pressing the switch 3x briefly with intervals of max. 1 second in normal running/operation mode will trigger the instrument to “show” its bus address/MAC-ID and baud rate. For indication the bus-address/MAC-ID the green LED will flash the amount of tens and the red LED the amount of units in the number. For indication of baud rate setting, both LED’s will flash. The flashes are called “count-flashes” and have a pattern of 0.5 sec. on, 0.5 sec. off.

LED indications for bus-address/MAC-ID and baud rate (press switch 3x briefly)			
LED	LED	Time	Indication
● Green	● Red		
amount of count flashes (0...12)	Off	0 ... 12 sec. Maximum	tens in bus-address/MAC-ID for instrument
off	Amount of count flashes (0...9)	0 ... 9 sec. Maximum	units in bus-address/MAC-ID for instrument
amount of count flashes (0...10)	amount of count flashes (0...10)	0 ... 10 sec. Maximum	baud rate setting for instrument



Value zero will be indicated by a period of 1 sec. off (0.5 sec. off + 0.5 sec. off).

Examples:

- For bus address/MAC-ID 35 the green LED will flash 3 times and the red LED will flash 5 times.
- For bus address/MAC-ID 20 the green LED will flash 2 times and the red LED will flash 0 times.
- For bus address/MAC-ID 3 the green LED will flash 0 times and the red LED will flash 3 times.
- For bus address 126 the green LED will flash 12 times and the red LED will flash 6 times.

Baud rate index table for indication on the LED’s (in baud)									
FLOW-BUS		PROFIBUS DP		DeviceNet		Modbus		EtherCAT	
1	187500	0	not detected	1	125000	1	9600	1	10000000
2	400000*	1	9600	2	250000	2	19200		
		2	19200	3	500000	3	38400		
		3	45450			4	57600*		
		4	93750			5	115200*		
		5	187500						
		6	500000						
		7	1500000						
		8	3000000						
		9	6000000						
		10	12000000						



*MBC3 type instruments have additional baud rates available for the several field busses.



EtherCAT bus address is always '0'.

Examples:

- For PROFIBUS DP baud rate readout of 12000000 Baud, both LED’s will flash 10 times.
- For DeviceNet baud rate readout of 250000 Baud, both LED’s will flash 2 times.

11.3.3 Change bus-address/MAC-ID and baudrate:

Pressing the switch 5x briefly with intervals of max. 1 second in normal running/operation mode. Within the time-out period of 60 seconds it is possible to start changing the bus-address/MAC-ID of the instrument. For certain field bus systems it is necessary to select the baud rate also. Other field bus systems only have one baud rate or the baud rate setting will adapt to the setting of the master automatically. In these cases baud rate selection is not needed and will be skipped.

Procedure for changing bus-address/MAC-ID and baud rate				
step	action	Indication	time	handling
1	Start			Press the switch 5x briefly with intervals of max. 1 second in normal running/operation mode.
2	Set tens of bus-address/MAC-ID	<p>● Green LED flashes 0.1 sec on 0.1 sec off</p> <p>count-flashes start when switch is pressed: 0.5 sec on, 0.5 sec off</p>	time-out: 60 sec	<p>Press switch and count green flashes for tens of bus-address/MAC-ID. Release when wanted amount has been count.</p> <p>Counts up to max. 12 and then starts at 0 again. When counting fails, keep switch pressed and restart counting for next attempt.</p>
3	Set units of bus-address/MAC-ID	<p>● red LED flashes 0.1 sec on, 0.1 sec off</p> <p>count-flashes start when switch is pressed: 0.5 sec on, 0.5 sec off</p>	time-out: 60 sec	<p>Press switch and count red flashes for units of bus-address/MAC-ID. Release when wanted amount has been count.</p> <p>Counts up to max. 9 and then starts at 0 again. When counting failed, keep switch pressed and restart counting for next attempt.</p>
4	<p>Set baud rate of field bus communication.</p> <p>Only for specific types of field busses: e.g. DeviceNet. This part will be skipped if no baud rate needs to be selected.</p>	<p>both ● red and ● green LED flashes 0.1 sec on, 0.1 sec off</p> <p>count-flashes start when switch is pressed: 0.5 sec on, 0.5 sec off</p>	time-out: 60 sec	<p>Press switch and count red and green flashes for baud rate setting of the specific field bus. Release when wanted amount has been count.</p> <p>Counts up to max. 10 and then starts at 0 again. When counting failed, keep switch pressed and restart counting for next attempt.</p> <p>Note: selection of 0 means: No change</p>

Instrument returns to normal running/operation mode. Changes are valid when they are made within the time-out times.



*Value zero will be indicated by a period of 1 sec. off (0.5 sec. off + 0.5 sec. off).
When value zero is wanted, press switch shortly and release it again within 1 sec.*



Before each action of flash-counting, the LED's to be used for counting will flash in a high frequency. (Pattern: 0.1 sec on, 0.1 sec off). As soon as the switch is pressed-down, this LED (or both LED's) will be off and the counting sequence will start.

11.4 MICRO-SWITCH USE FOR READING/CHANGING CONTROL MODE:

11.4.1 Read control mode

For switching between different functions in use of a digital meter or controller several modes are available. More information about the available control modes can be found at parameter "Control mode".

Pressing the switch 2x briefly with intervals of max. 1 second in normal running/operation mode will trigger the instrument to "show" its control mode. For indication of the control mode number the green LED will flash the amount of tens and the red LED the amount of units in the number. The flashes are called "count-flashes" and have a pattern of 0.5 sec. on, 0.5 sec. off. The control mode numbers can be found at parameter "control mode"

View current control mode (press switch 2x briefly)			
LED		time	indication
● green	● red		
amount of count flashes (0...2)	off	0 ... 2 sec. maximum	tens in control mode number
off	amount of count flashes (0...9)	0 ... 9 sec. maximum	units in control mode number



Value zero will be indicated by a period of 1 sec. off (0.5 sec. off + 0.5 sec. off).

11.4.2 Change control mode:

For switching between different functions in use of a digital meter or controller several modes are available. More information about the available control modes can be found at parameter "Control mode".

Pressing the switch 4x briefly with intervals of max. 1 second in normal running/operation mode will trigger the instrument to "change" its control mode.

Change current control mode (press switch 4x briefly)				
step	action	indication	time	handling
1	Set tens of setpoint / control mode number	● green LED flashes 0.1 sec on 0.1 sec off Count-flashes start when switch is pressed: 0.5 sec on 0.5 sec off	time-out: 60 sec	Press switch and count green flashes for tens of control mode number. Release when wanted amount has been count. Counts up to max. 2 and than starts at 0 again. When counting fails, keep switch pressed and restart counting for next attempt.
2	Set units of setpoint / control mode number	● red LED flashes 0.1 sec on 0.1 sec off Count-flashes start when switch is pressed: 0.5 sec on 0.5 sec off	time-out: 60 sec	Press switch and count red flashes for units of control mode number. Release when wanted amount has been count. Counts up to max. 9 and than starts at 0 again. When counting failed, keep switch pressed and restart counting for next attempt.

Instrument returns to normal running/operation mode.

Changes are valid when they are made within the time-out times.

See parameter 'Control mode' for behaviour at power-up of the instrument.



Value zero will be indicated by a period of 1 sec. off (0.5 sec. off + 0.5 sec. off).
When value zero is wanted, press switch shortly and release it again within 1 sec.



Before each action of flash-counting, the LED's to be used for counting will flash in a high frequency. (Pattern: 0.1 sec on, 0.1 sec off). As soon as the switch is pressed-down, this LED (or both LED's) will be off and the counting sequence will start.

12 TESTING AND DIAGNOSTICS

All digital instruments have facilities to run self-test procedures for diagnostics. Most of the instrument functions will be tested automatically during start-up or normal running mode of the instrument. All results of testing or malfunctioning will be stored in special diagnostics registers in the non-volatile memory of the instrument. These registers will contain actual information about the functioning of the instrument. The red LED on top of the instrument is used to indicate if there is something wrong. The longer the LED is burning (blinking) red, the more is wrong with the instrument.

13 SERVICE

For current information on Bronkhorst® and service addresses please visit our website:

 <http://www.bronkhorst.com>

Do you have any questions about our products? Our Sales Department will gladly assist you selecting the right product for your application. Contact sales by e-mail:

 sales@bronkhorst.com

For after-sales questions, our Customer Service Department is available with help and guidance. To contact CSD by e-mail:

 support@bronkhorst.com

No matter the time zone, our experts within the Support Group are available to answer your request immediately or ensure appropriate further action. Our experts can be reached at:

 **+31 859 02 18 66**